

SHAPEOKO XL

ASSEMBLY GUIDE



Table of Contents

Welcome and Congratulations.....	1
Important Safety Instructions.....	2
Machine Operating Checklist.....	3
Step 1 Inventory.....	4
Step 2 Baseframe.....	12
Step 3 Carriages.....	16
Step 4 Gantry.....	24
Step 5 Belting.....	28
Step 6 Drag Chain.....	34
Step 7 Proximity Switches.....	42
Step 8 Wiring.....	46
Step 9 Cleanup.....	50
Step 10 Compact Router.....	54
Step 11 Level and Square.....	58
Next Steps.....	59
Connect to Power.....	60
Download the Software.....	60
Configure Carbide Motion 5.....	61
Workholding.....	63
Cutting Tutorials and Projects.....	64
User Guides and Video Tutorials.....	64
Glossary of Terms.....	65

Have Questions? Need Help?

We have a fully-staffed support team waiting to help if you run into any trouble while assembling your Shapeoko XL. Just send us an email at support@carbide3d.com and we'll get back to you right away!

Welcome and Congratulations

You are now the proud owner of the Shapeoko XL, an incredibly powerful and easy-to-use CNC machine. In this guide we will walk you step-by-step through the assembly of your Shapeoko XL. If you run into any problems along the way, send us an email at support@carbide3d.com and we'll help get you back on track!

Important Notes Used in This Guide

Throughout the guide, you will find information that we've called out for you to pay particular attention to. We use three types of call-outs: **Warnings**, **Notes**, and **Pro Tips**:

WARNING: This is a warning. Information in these boxes is VERY important. Pay close attention.

NOTE: This is a note—information that points out critical steps or information for future reference.

PRO TIP: This is a pro tip. Anytime you see one of these, you will find helpful additional information.

Do NOT Use Power Tools

Use hand tools only. Do NOT use power tools to assemble your Shapeoko XL.

Finger-Tight Only

Several steps rely on “non-tightened fasteners.” Do not tighten fasteners beyond finger-tight until instructed to do so.

Firmware

The Shapeoko XL Carbide Motion board ships with GRBL 1.1 firmware, which must be used with Carbide Motion 5. This document supersedes any information you may find regarding firmware and software on the Carbide 3D website.

Stepper Motors

Your Shapeoko gantry is powered by stepper motors. When the power is off, moving the motors by hand will cause them to generate electricity.

WARNING: When moving the gantry by hand, go slowly. The power generated by the stepper motors will feel like bumps. If the lights on the Carbide Motion board are lighting up, it's very important to slow down because you are pushing electricity back through the board. Too much back flow could damage the Carbide Motion board.

Important Safety Instructions

The Shapeoko is a machine tool and requires the same caution that should be exercised with any power tool.

Eye Protection

Always wear safety glasses or goggles which are suitably impact resistant.

Hearing Protection

Always wear ear plugs or ear muffs. For long jobs, it may be desirable to wear both. Hearing damage is cumulative and irreversible, so one should always err on the side of caution.

Respiratory Protection

Always wear a filter or respiratory mask suitable for the type of dust generated by the material being cut. If necessary, arrange for dust collection and proper ventilation.

Clothing, Hair, and Jewelry

Always ensure that clothing, hair, and jewelry cannot become caught in the machine. Always wear appropriate clothing: long-sleeved shirts, pants, and suitable footwear are recommended. When doing metal-working, gloves and an apron are also recommended.

Machine Safety

Never reach into the machine's working envelope while it is running. Always shut off and unplug the router to perform tool changes, adjustments, and maintenance. Never leave the machine running unattended. Always inform someone before operating the machine and check in with them after successfully completing work. Never allow children to use the Shapeoko XL unsupervised.

Fire Prevention

Consider the possibility of a fire caused by friction from the router and take suitable fire prevention precautions (e.g. having a fire extinguisher handy and other suitable precautions).

Outlet Requirements

Plug the router into an outlet that has a dedicated on/off switch. Be sure this is accessible while the machine is running, in case you should need to shut off the Shapeoko XL immediately.

End Mill Safety

Use care when handling end mills—both to avoid being cut and to avoid damaging them. Handling end mills with suitable gloves, or using a cloth to avoid contaminating them, is recommended. Inspect end mills carefully before each use and ensure that they are securely held by the collet.

Debris Disposal

Recycle or safely dispose of milling debris and dust, keeping in mind flammability, (potential) spontaneous combustion, and chemical considerations. Even natural materials can have surprising disposal implications. For example, walnut wood dust is allelopathic (it inhibits plant growth), an irritant to the skin and respiratory tract, and potentially poisonous to some animals. All of these possible disposal implications are in addition to the spontaneous combustion hazard posed by all types of sawdust.

Machine Operating Checklist

1. Be Safe

Always follow the safety guidelines listed on the previous page. Always wear appropriate safety equipment, especially safety glasses/goggles, hearing protection, and respiratory protection.

2. Check the Machine

Check that all bolts and set screws are tight, V-rails are in good condition with no nicks or other damage, belts are tight and in good shape, wiring is in good condition with continuity and securely fastened, and that nothing is frayed or broken and everything is clear and safe.

3. Secure the Workpiece

Secure the workpiece (the material being milled) right-side up and in the desired orientation to the worksurface using a technique appropriate to the material. After securing the workpiece, be certain that the machine is still able to move.

4. Mount the Router

Mount an appropriate compact router; ensure that it is vertical, square to the machine, and well-secured.

5. Examine the End Mill

Examine each end mill prior to use to ensure that it is sharp, in good condition, and not chipped (this is best done with a loupe or magnifying glass). Install the end mill per the compact router manufacturer's directions so that it projects at least as much as the deepest intended cutting depth. Check to make certain that the collet is tight and will not work loose during operation (it needs to be more than finger-tight—the machine will take no notice or care if it works loose).

6. Clear the Work Area

Ensure the work area is clear and all cables run without interference. Most importantly, check that there is nothing beneath the rails which might interfere with the movement of the carriages.

7. Connect to a Computer

To connect the Shapeoko XL to a computer:

- a. Power up the computer.
- b. Connect the USB cable to the port at the rear of the Carbide Motion board and to your computer.
- c. Start Carbide Motion 5 on your computer.
- d. Turn the Shapeoko XL on by flipping the in-line rocker switch on the power supply cord to the ON position. Once powered on, you will see a steady blue LED light on the Carbide Motion board through a slit in the enclosure cover.
- e. Open the connection to the machine (it should connect and allow you to home the machine).
- f. If necessary, home the cutting tool to the proper place in relation to the workpiece.

8. Disconnect the Touch Probe

If you're using a Touch Probe, remove the ground clip and secure it safely outside of the machine's working envelope

9. Double Check the Work Area

Ensure that nothing has been left in the work area. Optionally, you may traverse the working boundary of the job as a final check.

10. Send NC File to Machine

Load the NC file (the G-code which gives the machine its instructions). Start the compact router as required and set it to the correct speed. Follow all prompts for tool changes.

11. Monitor the Machine During Operation

While staying clear of the work area, monitor the machine during operation. Ensure there is no build-up of dust, debris, or fumes, and that nothing works loose. Do not reach into the machine's working envelope or insert any object into it while the machine is operating.

12. Finish and Clean Up

Once the job is complete, turn off the router, return the gantry to the home position or a known offset from home, and ensure the end mill has stopped spinning before removing the finished piece and any waste. Store end mills carefully when not in use to protect the cutting edges. Collets and accessories should be cleaned between uses. Wipe them off with a suitable solvent such as isopropyl alcohol.

Step 1 Inventory



Figure 1-2

Unbox the Shapeoko XL

Let's begin by making sure that everything is accounted for and free from any shipping damage. Remove all of the boxes and components from the shipping container. Once you have unpacked everything you should have the items listed below and shown in **Figure 1-2**.

Item	Description	Qty	Other Info
A	Shapeoko XL Assembly Guide	1	This Printed Assembly Guide
B	Y-Axis Left Assembly Box	1	Contains Y-Axis Left Carriage
C	Y-Axis Right Assembly Box	1	Contains Y-Axis Right Carriage
D	XL Final Assembly Box	1	Contains Hardware and Components Needed for Assembly
E	X/Z+ Box	1	Contains the Z-Plus Carriage, Components, and Hardware
F	Pre-Assembled XL Wiring Harness Box	1	Contains Wiring Harness, Kits, and Hardware
G	Sweepy Box (65mm or 69mm)	1	Sweepy Dust Boot
H	Cross Strap Package	1	23.5" x 7" x 1.5" Package Contains 3 Identical Cross Straps
I	Aluminum Extrusion Rails Package	1	40" x 7.5" x 3.5" Package Contains 3 Unique Extrusion Rails
J	Endplate Package	1	45.5" x 8" x 2" Package Contains 2 Identical Endplates
K	MDF Baseplate Board	1	41" x 22.8" x 0.75"

Optional Items

L	Carbide Compact Router Box	1	Contains the Compact Router and Accessories/Tools
---	----------------------------	---	---

Take Inventory

Now, take a full inventory of all components using the checklists on the following pages. Inspect items for damage and quantity, then carefully set each aside until they are needed for assembly.

PRO TIP: Your Shapeoko XL kit has been carefully packaged by hand and double checked for accuracy. If, after completing your inventory, you find that something is missing or damaged, contact us at support@carbide3d.com and we'll ship it to you ASAP.

Y-Axis Left Assembly & Y-Axis Right Assembly Boxes

Open the boxes labeled Y-Axis Right Assembly and Y-Axis Left Assembly and visually verify they match the carriages shown in **Figure 1-3**. The Right and Left Assembly are mirror images.

NOTE: Save both Y-Axis Assembly boxes and the foam packing blocks inside. They'll be used to support the gantry during assembly.

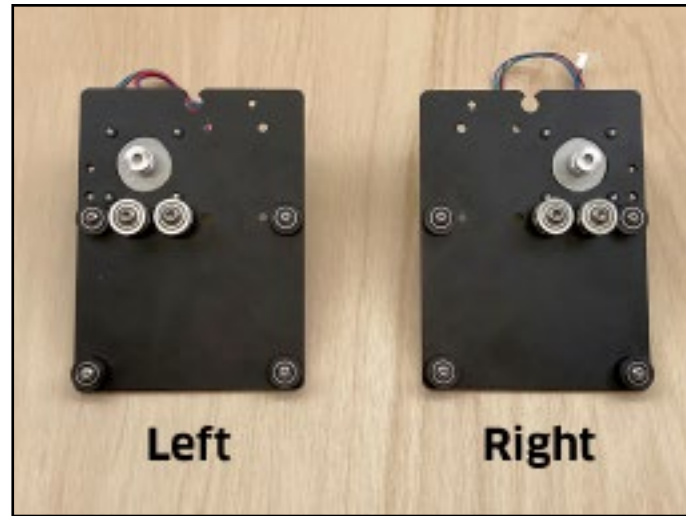

Figure 1-3

XL Final Assembly Box

Open the box labeled XL Final Assembly and inspect its contents. Many parts are packaged in small plastic bags, and smaller bags may be packed into larger bags. This box contains the items listed in the table on the next page and shown in **Figure 1-4**.



Figure 1-4

XL Final Assembly box contents; see **Figure 1-4**:

Item	Description	Qty
A	Baseframe Hardware: M5 x 25mm Button Head Cap Screws (+3 Extra)	18
B	Baseframe Adjustable Leveling Feet	4
C	Router Mount	1
D	Router Mount Adapter Ring	1
E	Router Mount Hardware: M5 x 55mm Socket Head Cap Screws (2) and M5 x 16mm Button Head Cap Screws (2)	4
F	Loctite 242 Threadlocker (non-permanent)	1
G	Extrusion Rail Hardware: M6 x 12mm Button Head Cap Screws	24
H	Belt Clips (6) and Belt Hardware: M5 x 10mm Socket Head Cap Screws (6)	12
I	Toothed Belt	3
J	Carbide Motion Board and Enclosure and Mounting Hardware (inside): M6 x 8mm Button Head Cap Screw (2)	3
K	Shapeoko Decal	1
L	Power Cord	1
M	Power Supply	1
N	USB Cable	1
O	Large Zip Tie	2
P	Permanent Marker	1
Q	#201 1/4-inch Square End Mill Cutter	1
R	Tool Kit: 5, 4, 3, 2.5, 2, and 1.5mm Hex Keys*; 10 and 8mm Wrenches	8

*The 5mm hex key is provided in case you need to adjust the stepper motor idlers; the 1.5mm hex key is provided in case you need to adjust the motor pulley set screws.

X/Z+ Box

This box should contain all the items listed in the table below and shown in **Figure 1-5**.

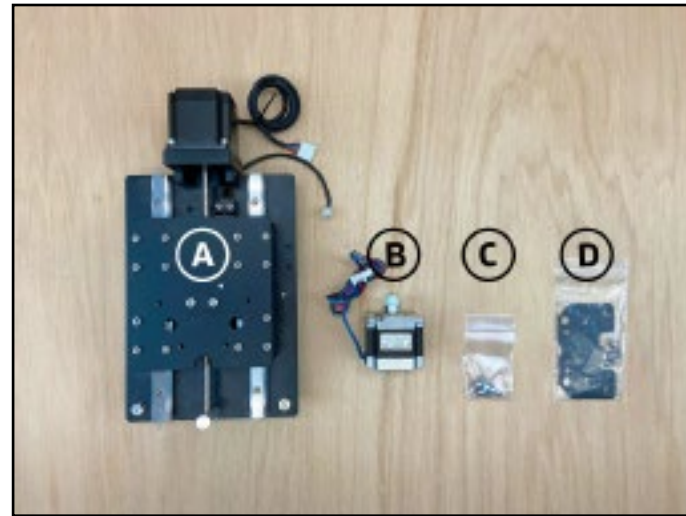

Figure 1-5

Item	Description	Qty
A	Z-Plus Carriage with Z-Axis Stepper Motor and Z-Axis Proximity Switch	1
B	X-Axis Stepper Motor	1
C	M5 x 10mm Socket Head Cap Screw	4
D	Trimming Plate and Hardware: M5 x 8mm Socket Head Cap Screws (4)	5

Pre-Assembled XL Wiring Harness Box

This box should contain all the items listed in the table below and shown in **Figure 1-6**.



Figure 1-6

Item	Description	Qty
A	Pre-Assembled Wiring Harness (X-Axis and Y-Axis Drag Chains and Cables)	1
B	Drag Chain Support Brackets (6 +1 Extra), Hardware: M4x6mm (8 +2 Extra), M5x8mm (2), M5x16mm (2) Socket Head Cap Screws, M5 Nuts (2), M3x4mm Flat Head Screws (6)	29
C	Proximity Switch Plates (2) and Hardware: M3x18mm (4), M5x8mm (4) Socket Head Cap Screws, 30mm Male-to-Female Standoffs (2)	12
D	Cable Tie Mounts (5), Cable Ties (25), Hardware: M4x6mm Socket Head Cap Screws (5)	35
E	PCB Riser Board (Adapter Board for Proximity Switches)	1

Sweepy Box

The Sweepy Dust Boot is available for 65mm and 69mm routers. Open the Sweepy box and verify you received the correct diameter. See **Figure 1-7**.



Figure 1-7

Cross Straps

The three (3) cross straps are identical. See **Figure 1-8**. Each cross strap has one (1) integrated PEM nut. Inspect each nut to verify threads are properly formed and that it is seated squarely in place.



Figure 1-8

Aluminum Extrusion Rails

Examine the three rails, shown in **Figure 1-9**, and identify the following:

- **X-Axis Rail (X-Rail):** has Shapeoko/warning decals on the front and sixteen (16) M4 threaded screw holes along the back.
- **Y-Axis Left Rail (Y1-Rail):** has two (2) M6 and two (2) M4 threaded screw holes along one side.
- **Y-Axis Right Rail (Y2-Rail):** has two (2) M6 threaded screw holes along one side.

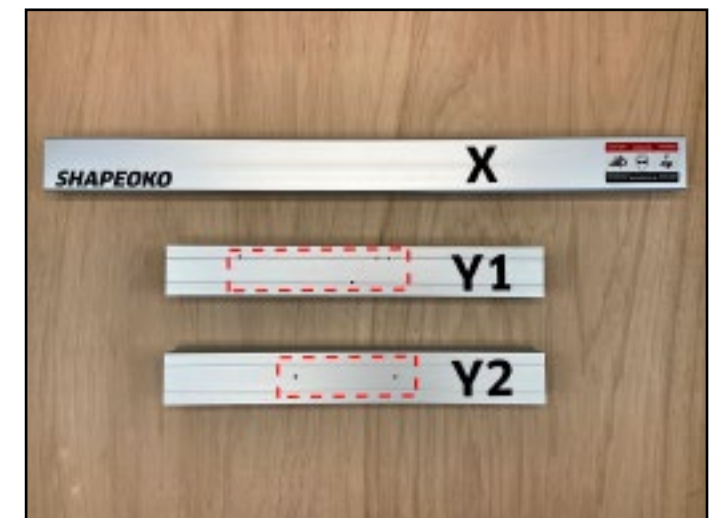

Figure 1-9

Endplates

The two (2) endplates are identical. See **Figure 1-10**.

Each endplate has eight (8) integrated PEM nuts. Inspect each nut to verify threads are properly formed and that it is seated squarely in place.



Figure 1-10

MDF Baseplate

The MDF baseplate is packed in the bottom of the shipping box. Identify the MDF baseplate pictured in **Figure 1-11**.

WARNING: MDF is sensitive to moisture. Avoid liquids and/or high humidity. If you are in a high-humidity environment, consider sealing the MDF baseplate with a suitable finish, such as spar urethane or lacquer.



Figure 1-11

Carbide Compact Router Box

Optional Equipment. If you ordered the Carbide Compact Router with your kit, you will receive everything shown in **Figure 1-12**.



Figure 1-12

Additional Required Tools

The following tools are not included in your Shapeoko kit, but are required for assembly. See **Figure 1-13**:

Item	Description	Qty
A	Flush Cut Pliers or Scissors	1
B	Level	1
C	Ruler	1

Recommended Tools

The following tools are recommended for assembly, but not included. See **Figure 1-13**:

Item	Description	Qty
D	8 and 10mm Combination Wrench	2
E	Easy-Peel Masking Tape (e.g. blue painter's tape; nothing that leaves a residue behind)	1
F	Flashlight	1
G	Tape Measure	1

Before You Begin Assembly

This guide contains many instructions with a directional reference, such as: **left, right, front, back, rear, inside, outside**, etc.

All such references are from the perspective of one standing in front of, and looking at, the machine as shown in **Figure 1-14**. This is true even if pictorial figures are of the sides or back of the machine. As much as possible the words "left" and "right" have been replaced with "Y1" and "Y2" respectively. Take a minute to familiarize yourself with this view of the machine.

In addition to adopting a front-view perspective, familiarize yourself with the machine's directional axes: the X-Axis moves left and right, the Y-Axis moves front and back, and the Z-Axis moves up and down. See **Figure 1-15**.

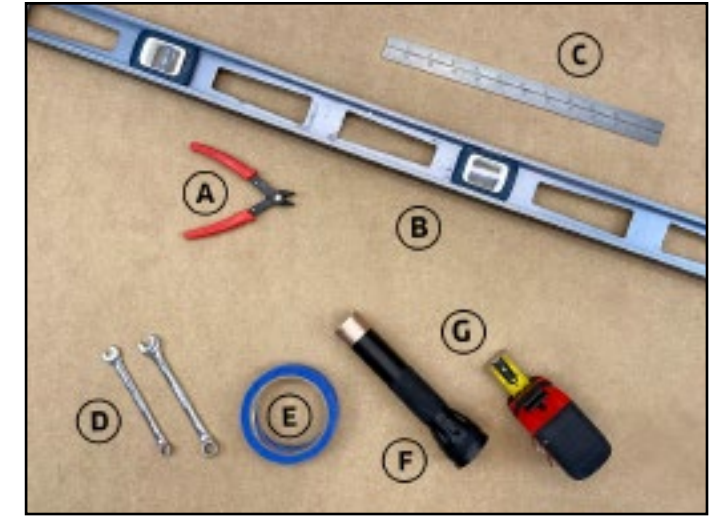

Figure 1-13

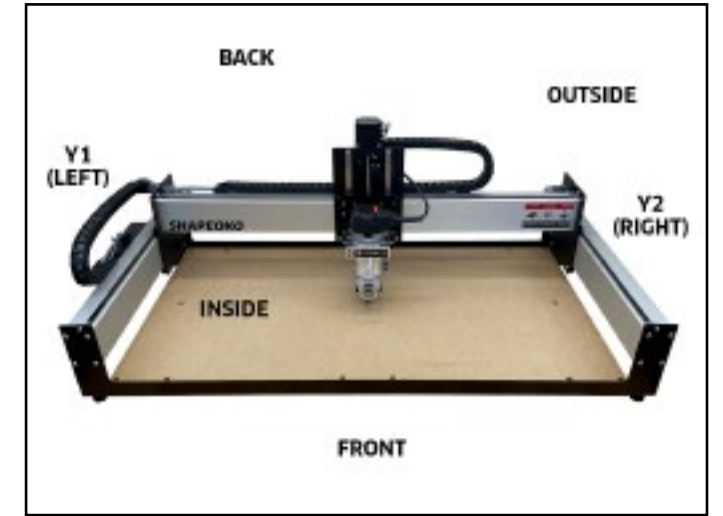

Figure 1-14



Figure 1-15

Step 2 Baseframe

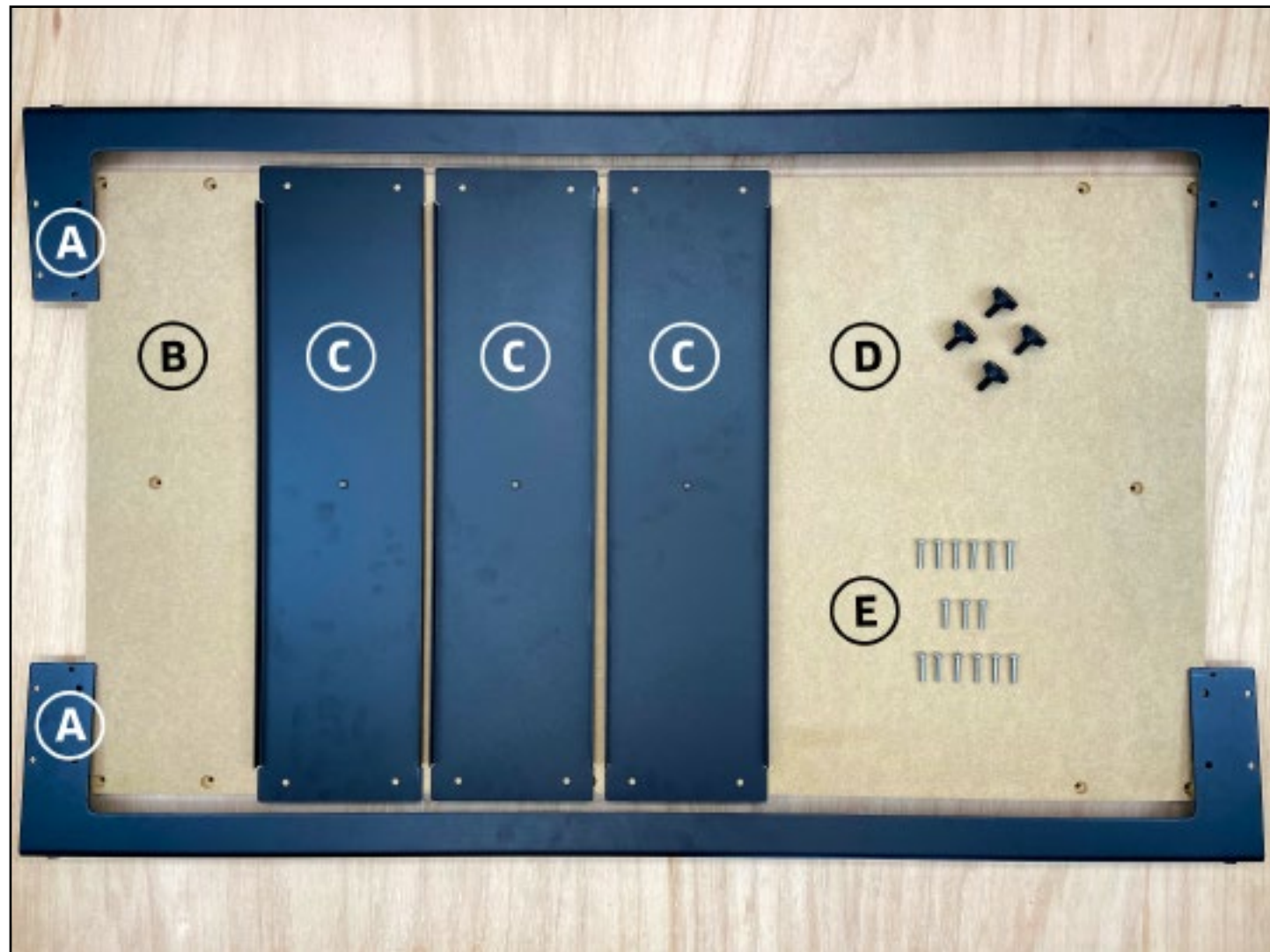

Figure 2-2

Required Components

See **Figure 2-2**:

Item	Description	Location	Qty
A	Endplate	N/A	2
B	MDF Baseplate	N/A	2
C	Cross Strap	N/A	3
D	Adjustable Leveling Foot	XL Final Assembly Box	4
E	M5 x 25mm Button Head Cap Screw	XL Final Assembly Box	15

Required Tools

See **Figure 2-3**:

Item	Description	Qty
A	3mm Hex Key	1
B	Level (not included)	1

Recommended Tools

See **Figure 2-3**:

Item	Description	Qty
C	Spare Hex Key (included)	2 or 3
D	Flashlight	1
E	Tape Measure	1

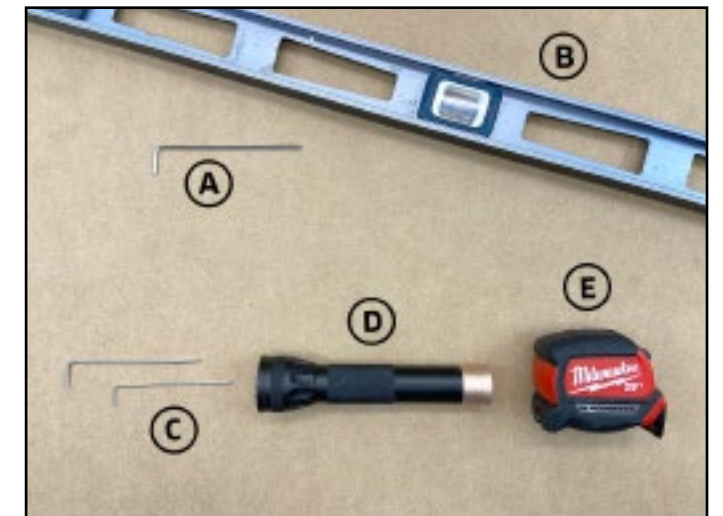

Figure 2-3

Position the Cross Straps

WARNING: Do not assemble the Shapeoko on the floor; a large workbench is essential. The completed dimensions of the Shapeoko XL are 44.8" (X) x 23.9" (Y) x 18.5" (Z).

1. Lay the three (3) cross straps parallel, front-to-back, with the flanges down, and 12 inches apart. See **Figure 2-4**.

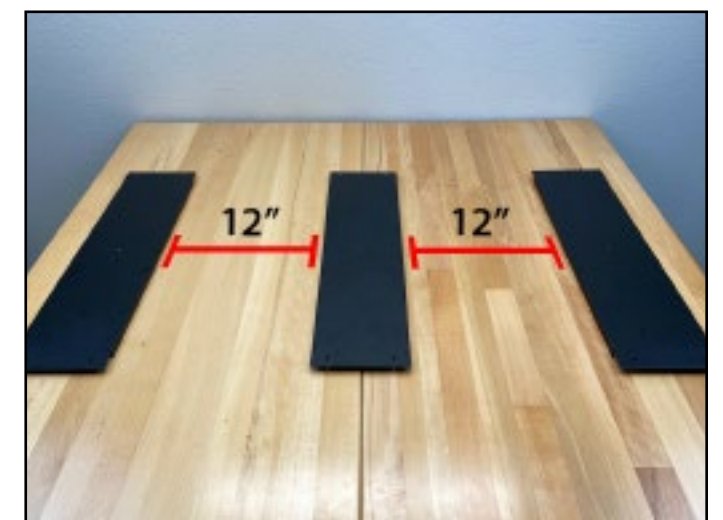

Figure 2-4

Attach the MDF Baseplate

1. Lay the MDF baseplate over the three cross straps, with the countersunk holes facing up.

PRO TIP: Use a spare hex key or two to align the middle three screw holes. See **Figure 2-5**. To further help with hole alignment, shine a flashlight under the assembly to illuminate the holes from the bottom. Adjust as necessary.

2. Use the 3mm hex key and three (3) M5x25mm button head cap screws to secure the MDF baseplate across the middle. See **Figure 2-5**.

NOTE: We'll come back and tighten all of the baseframe screws later on when squaring the machine.

3. Turn the screws until they stop but do not fully tighten.

Attach the Rear Endplate

1. Slide one (1) endplate **UNDER** all three cross straps along the rear of the baseframe and align the screw holes. See **Figure 2-6**.
2. Use the 3mm hex key and six (6) M5x25mm button head cap screws to secure the rear endplate to the baseframe. See **Figure 2-7**.
3. Turn the screws until they stop but do not fully tighten.

NOTE: If you are having trouble getting any of the endplate screws to line up, try starting from the center and alternating your way out to the ends. Apply a little more downward force, but be careful not to cross-thread. Screws may fit tightly but they should not wobble when turned. Still having trouble? Contact us at support@carbide3d.com.

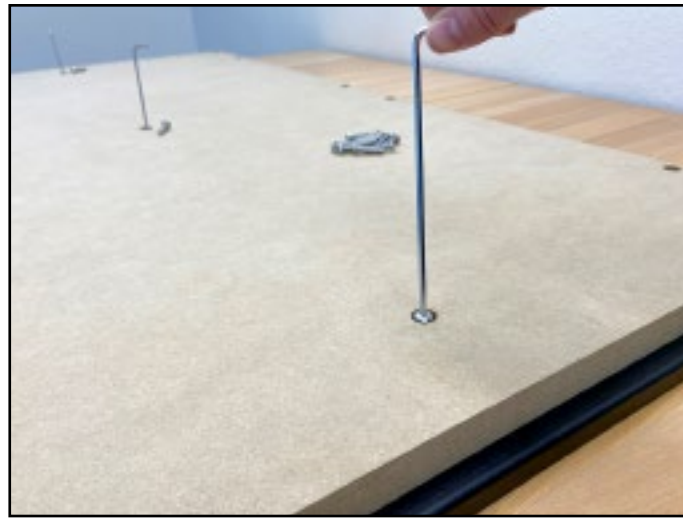

Figure 2-5



Figure 2-6

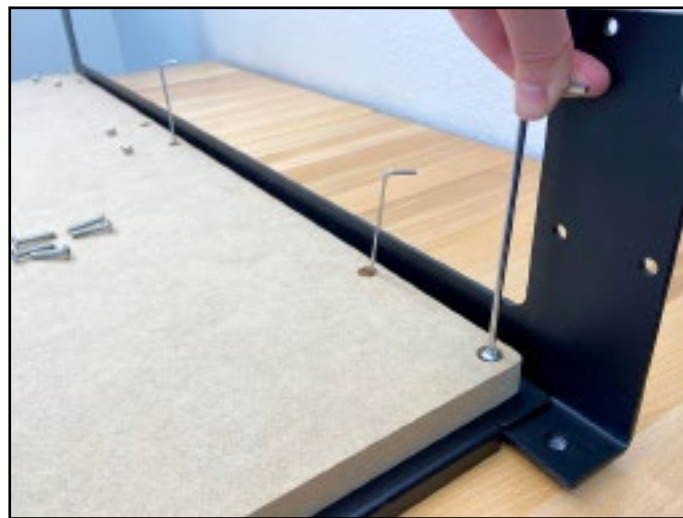

Figure 2-7

Attach the Front Endplate

1. Slide the remaining endplate **UNDER** all three cross straps along the front of the baseframe and align the screw holes.
2. Use the 3mm hex key and six (6) M5x25mm button head cap screws to secure the front endplate to the baseframe. See **Figure 2-8**.
3. Turn the screws until they stop but do not fully tighten.

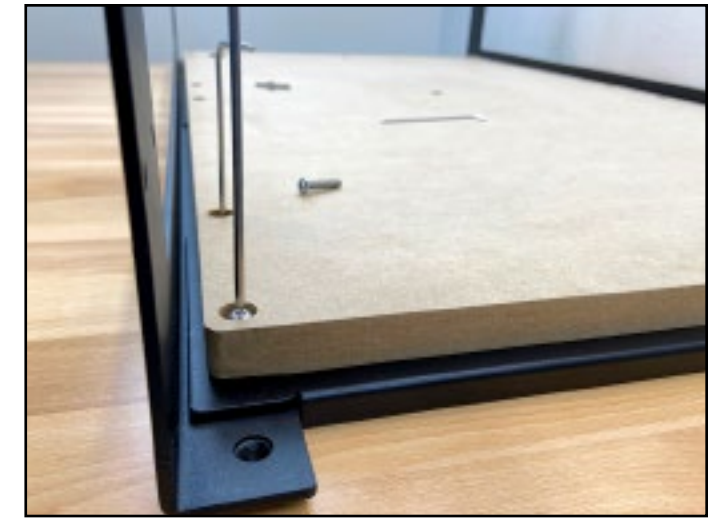

Figure 2-8

Attach the Adjustable Leveling Feet

1. Lift/prop each corner of the baseframe and screw in the four (4) adjustable leveling feet until flush with the top of the endplate. See **Figure 2-9**.



Figure 2-9

Level the Baseframe Assembly

1. Adjust the height of each leveling foot to bring the fully assembled baseframe into level. Check level front-to-back, side-to-side, and diagonally. See **Figure 2-10**.
2. Optionally, you can check for square by measuring diagonally across the baseframe from the outside edges of the endplates. Check both sides. The machine is square when the two measurements are equal. Approximates are acceptable at this stage as the machine is not fully tightened. A final level and square is completed in **Step 11: Level and Square**.



Figure 2-10

Step 3 Carriages

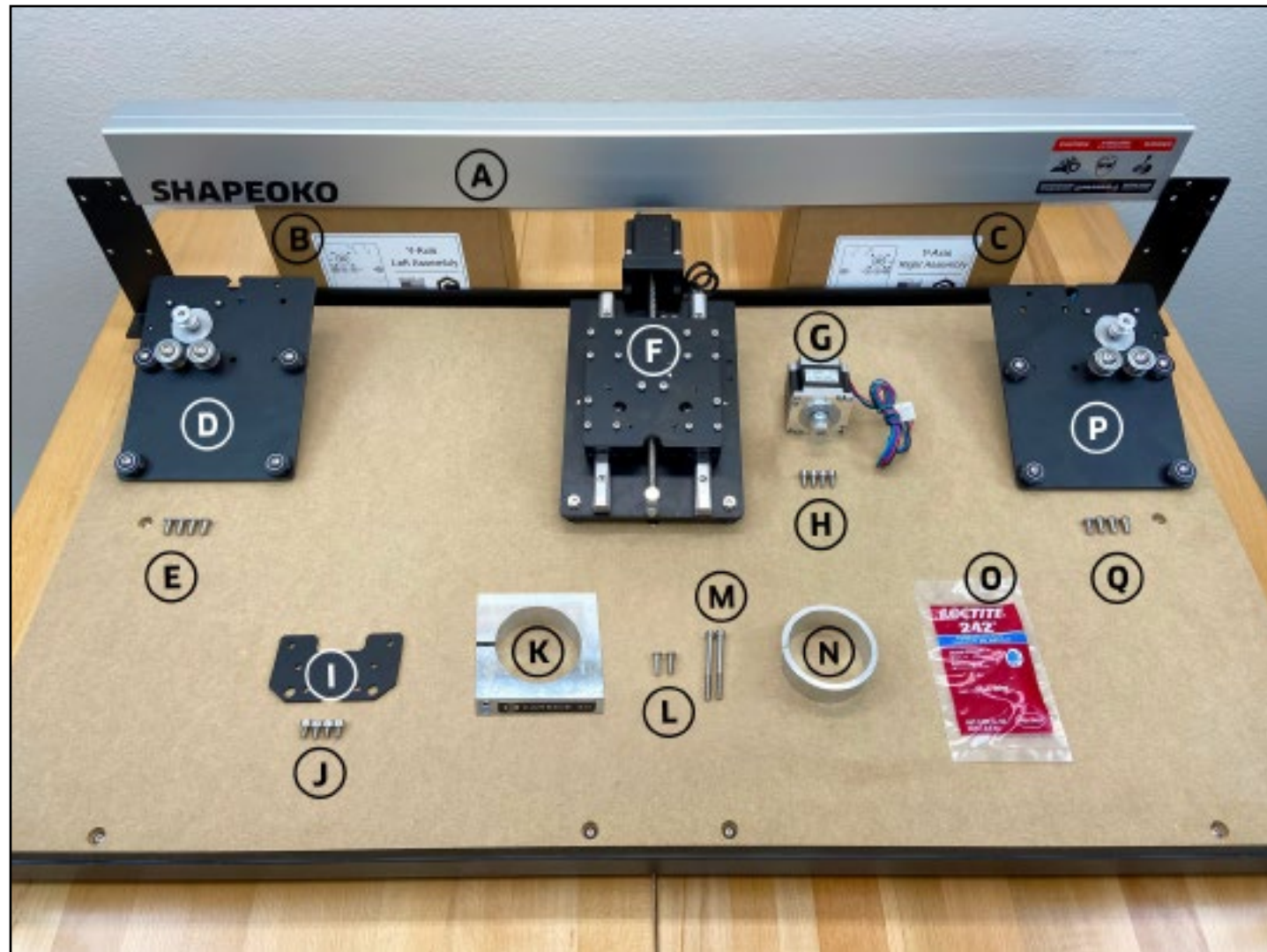
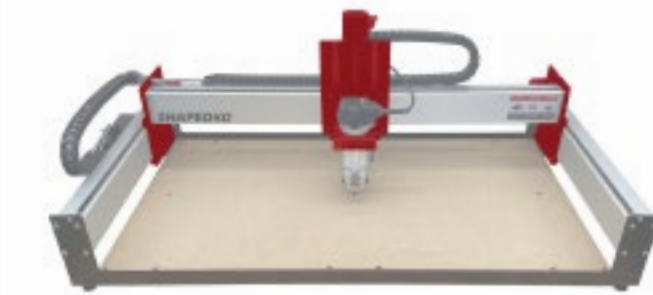

Figure 3-2

Required Components

See **Figure 3-2**:

Item	Description	Location	Qty
A	X-Axis Aluminum Extrusion Rail (X-Rail)	N/A	1
B	Y-Axis Left Assembly Box (empty)	N/A	1
C	Y-Axis Right Assembly Box (empty)	N/A	1
D	Y-Axis Left Carriage (Y1-Carriage)	Y-Axis Left Assembly Box	1
E	M6 x 12mm Button Head Cap Screw	XL Final Assembly Box	4
F	Z-Plus Carriage (Z-Plus)	X/Z+ Box	1
G	X-Axis Stepper Motor (X-Motor)	X/Z+ Box	1
H	M5 x 10mm Socket Head Cap Screw	X/Z+ Box	4
I	Tramming Plate	X/Z+ Box	1
J	M5 x 8mm Socket Head Cap Screw	X/Z+ Box	4
K	Router Mount	XL Final Assembly Box	1
L	M5 x 16mm Button Head Cap Screw	XL Final Assembly Box	2
M	M5 x 55mm Socket Head Cap Screw	XL Final Assembly Box	2
N	Router Mount Adapter Ring	XL Final Assembly Box	1
O	Loctite 242 Threadlocker	XL Final Assembly Box	1
P	Y-Axis Right Carriage (Y2-Carriage)	Y-Axis Right Assembly Box	1
Q	M6 x 12mm Button Head Cap Screw	XL Final Assembly Box	4

Required Tools

See **Figure 3-3**:

Item	Description	Qty
A	3 and 4mm Hex Key	2
B	10mm Wrench	1

Recommended Tools

See **Figure 3-3**:

Item	Description	Qty
C	10mm Combination Wrench	1
D	Masking Tape	1

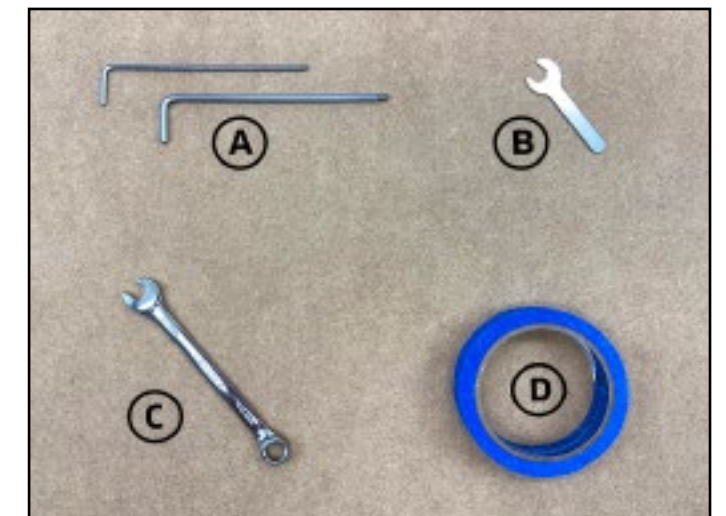

Figure 3-3

ECCENTRIC NUTS AND V-WHEELS EXPLAINED

Eccentric nuts and V-wheels are what we use to adjust the gantry at the intersect between the carriage V-wheels and the V-rails. A loose connection here is referred to as carriage slop. To eliminate slop, a very small amount of tension is added between the wheels and rail. Too much tension and the wheels will deform, causing bumpy and constrained motion. Not enough tension, and the carriages will wobble. When tension is just right, the carriages glide smoothly and without slop for the highest-quality cuts.

Our HD eccentric nuts, in combination with the attached V-wheel, operate as a cam, converting the rotational motion of turning the nut, into linear motion at the V-wheel. A dimple on one the side of the nut indicates the furthest point to center of the offset threads. When the dimple is facing UP, the distance between the top and bottom wheel is at its greatest and the V-wheels are OPEN. When the dimple is facing DOWN, the opposite is true, and they are CLOSED. See **Figures 3-4** and **3-5**.

When adding tension to a loose V-wheel, turn the eccentrics clockwise. Turning counter-clockwise will loosen the bolted connection between nut and wheel. If this happens, re-tighten with a 10mm wrench and a 3mm or 4mm hex key.

Not much tension is needed for the carriages to be secure. The wheels should only be snug against the rail. Reach under and spin the V-wheel with your finger. If it rotates freely, turn the eccentric nut clockwise until you feel some friction against the rail and the carriage is free from slop.

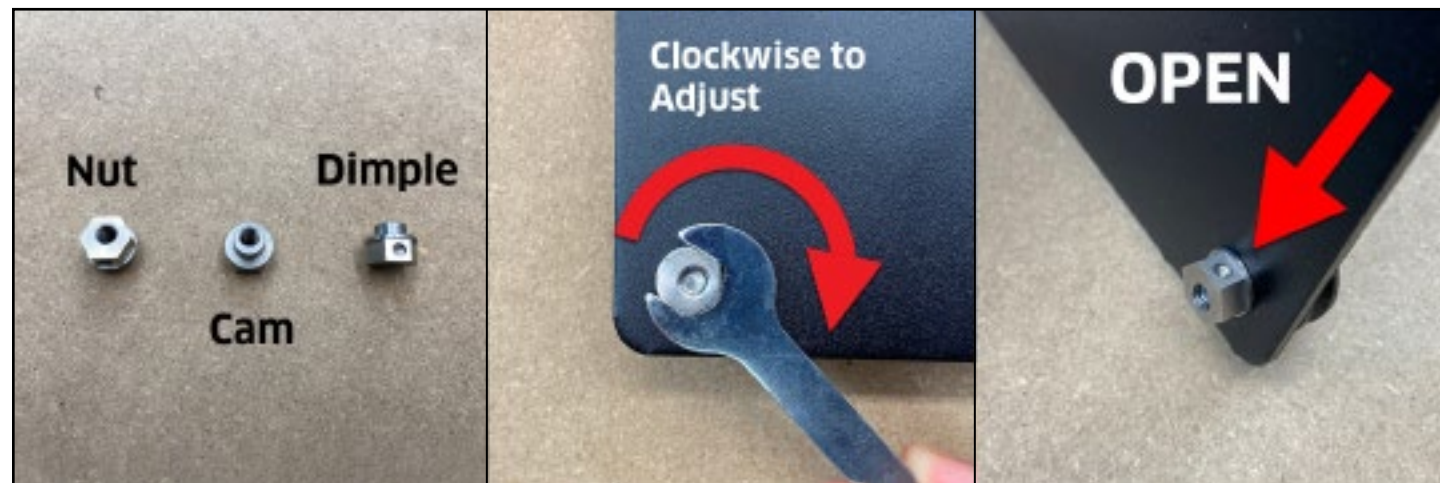

Figure 3-4

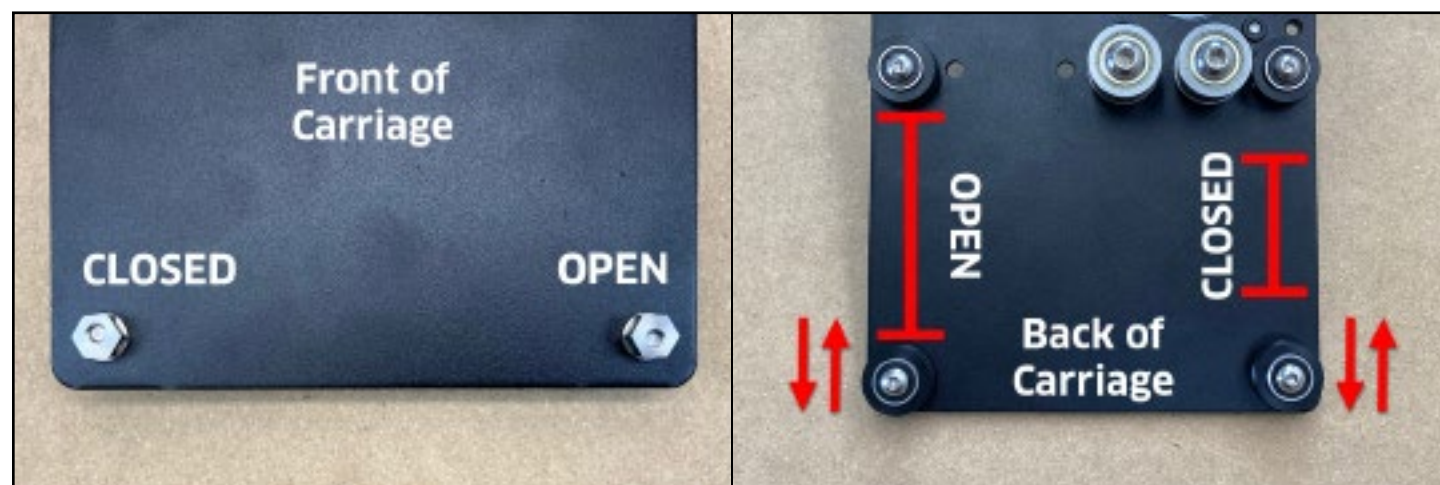

Figure 3-5

Open the V-Wheels

1. Gather the three (3) carriages. See **Figure 3-6**:
 - a. Y-Axis Left Carriage (Y1-Carriage)
 - b. X/Z-Axis Carriage (Z-Plus)
 - c. Y-Axis Right Carriage (Y2-Carriage)
2. Use the 10mm wrench and turn all six (6) eccentric nuts **CLOCKWISE** until the dimple is facing **UP**. Refer back to **Figure 3-4**.

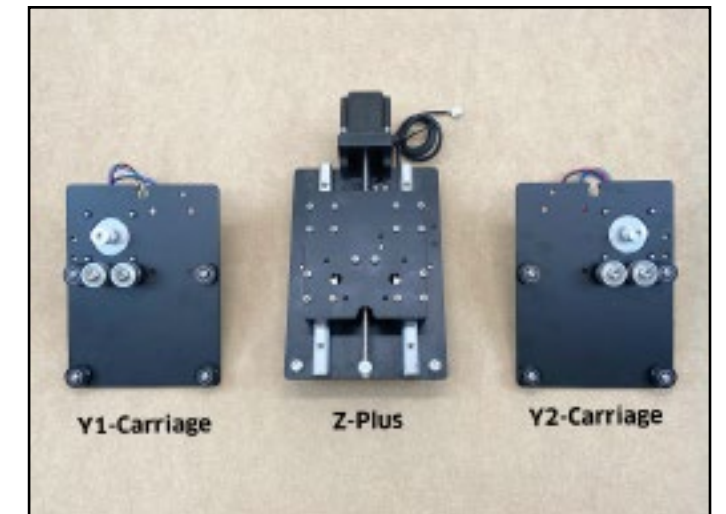

Figure 3-6

Assemble the Z-Plus

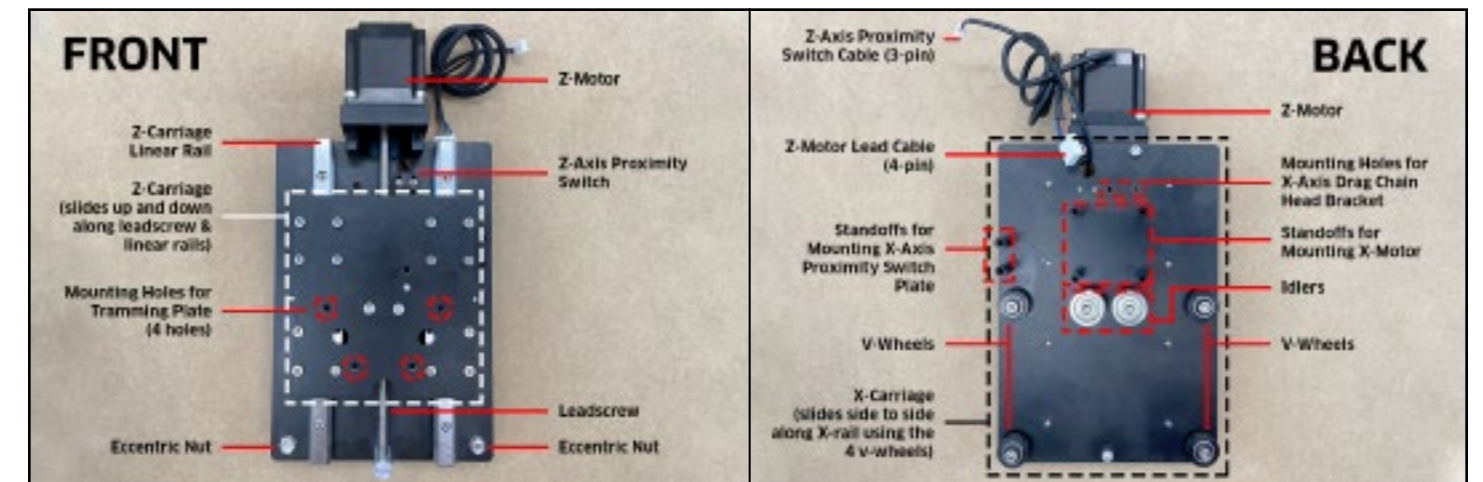

Figure 3-7

Attach the X-Motor

1. Familiarize yourself with the features and layout of the Z-Plus. See **Figure 3-7**.
2. Place the Z-Plus face down, with the six (6) 30mm standoffs pointing up.
3. Set the X-motor onto the four (4) evenly-spaced standoffs in the center of the Z-Plus, with the Carbide 3D label facing down (toward the idlers). See **Figure 3-8**.
4. Use the 4mm hex key and four (4) M5x10mm socket head cap screws to secure the X-motor to the Z-Plus.

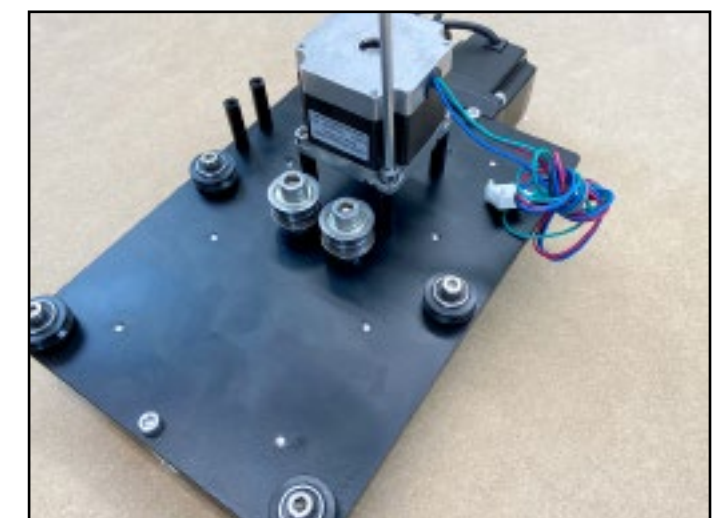

Figure 3-8

Identify the Front of the Tramming Plate

Tramming the router (adjusting left/right tilt) is a feature of the Z-Plus made possible by the tramming plate. Tramming before each new project sets the router mount perfectly parallel to the X-Axis and provides you with the most accurate cuts for the highest-quality finish.

Three of the four M5 mounting holes on the plate are enlarged by 0.75mm. The one standard-sized M5 mounting hole serves as a fixed point around which the plate can “wobble” by +/- 0.375mm left or right. We want this fixed point to be in the **UPPER-LEFT** corner when the plate is mounted to the Z-Plus. This is considered the **FRONT** of the tramming plate.

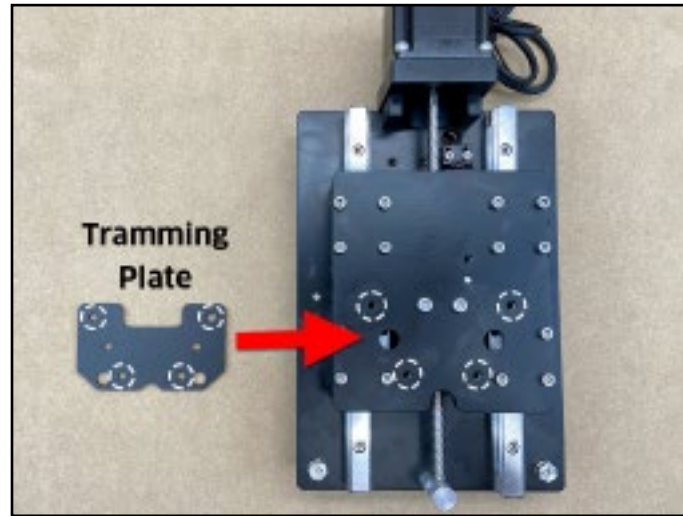

Figure 3-9

1. Position the tramming plate with the short legs extending up in a “U” shape. See **Figure 3-9**.
2. Inspect the top two screw holes to determine which of the two is the smaller.
3. Position the tramming plate with the smaller hole at **TOP-LEFT**. This is the **FRONT** of the plate.

PRO TIP: Insert the tramming plate hardware, two (2) M5x8mm screws, from the back and examine each screw hole for a gap. Mark the smaller, standard-sized M5 screw hole with a piece of tape. See **Figure 3-10**.

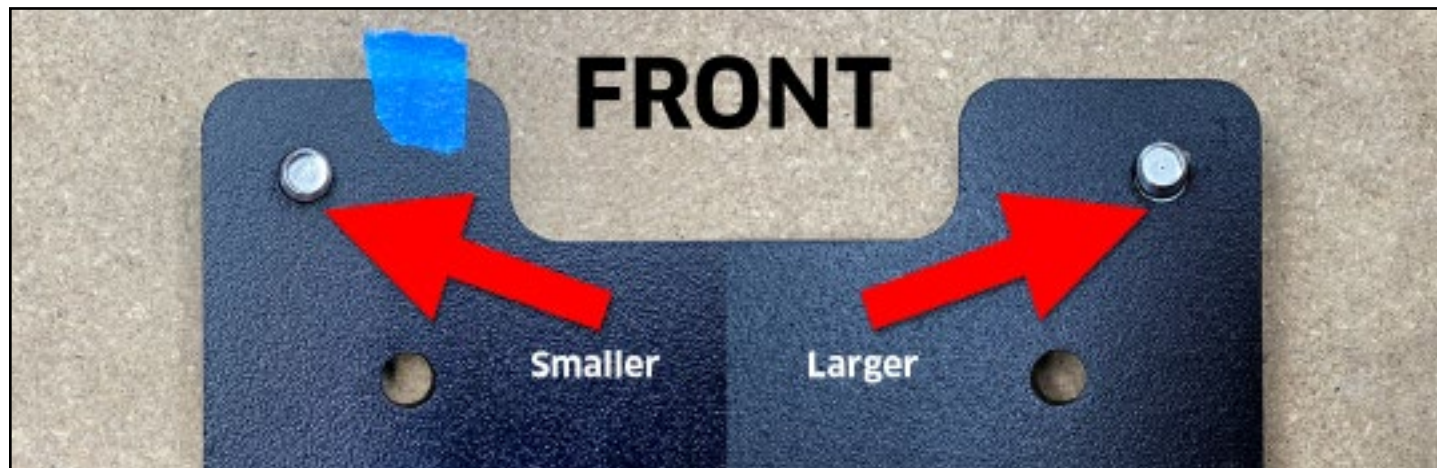

Figure 3-10

Attach the Router Mount to the Tramming Plate

The router mount attaches to the **FRONT** of the tramming plate with the Carbide 3D logo facing **UP**.

1. Add one drop of Loctite 242 Threadlocker to the threads of the two (2) pocketed screw holes at the back of the router mount **AND** the threads of the two (2) M5x16mm button head cap screws.

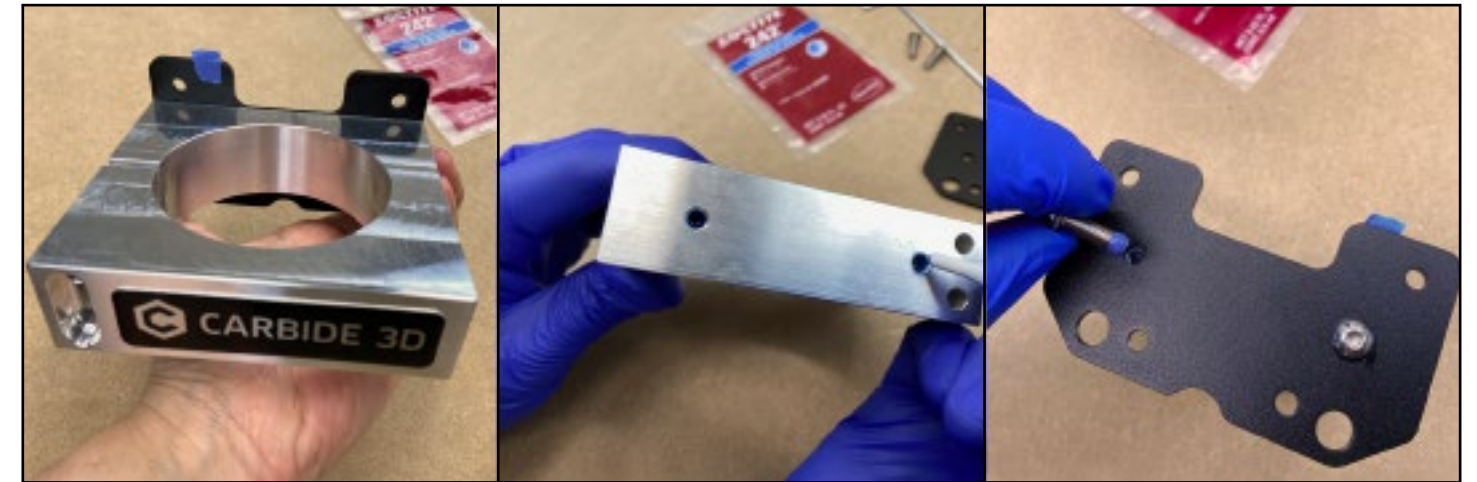

Figure 3-11

2. Use the 3mm hex key and the two (2) M5x16mm button head cap screws to secure the router mount to the **FRONT** of the tramming plate and fully tighten. See **Figure 3-11**.

Attach the Tramming Plate to the Z-Plus

1. Set the tramming plate onto the front of the Z-Plus and align the four (4) mounting holes with the four (4) available M5 screw holes.
2. Use the 4mm hex key and four (4) M5x8mm socket head cap screws to secure the plate to the Z-Plus. See **Figure 3-12**.
3. If you have a 65mm router (including the Carbide Compact Router), insert the router mount adapter ring into the router mount. If you have a 69mm router, you will not need the router mount adapter ring and can set it aside.
4. Use the 4mm hex key to insert the two M5x55mm socket head cap screws into the front of the router mount. Finger-tighten only.
5. Grasp the sides of the Z-Plus with both hands and lower the Z-carriage with your thumbs until it stops at the bottom. See **Figure 3-13**.

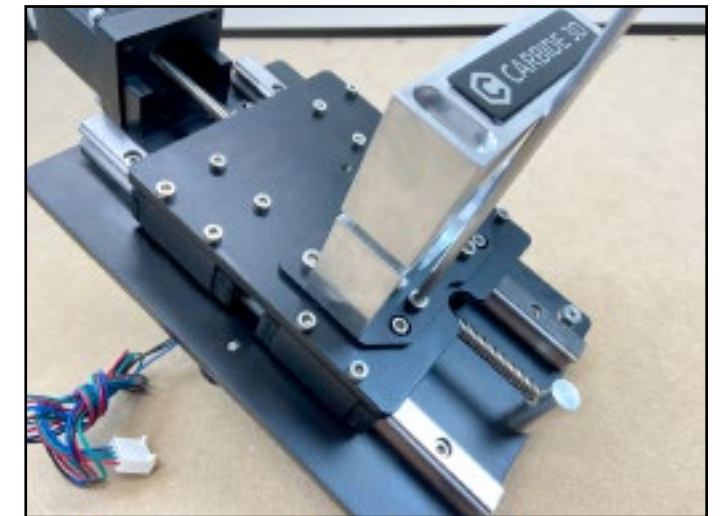

Figure 3-12

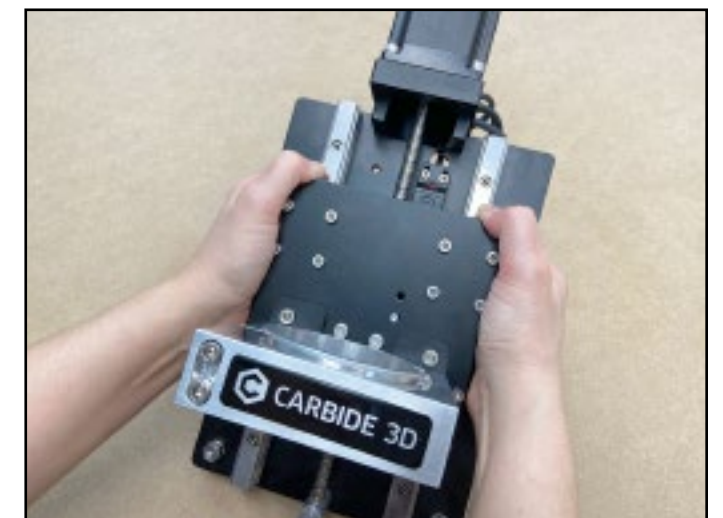

Figure 3-13

NOTE: Each extrusion rail has a pair of V-rails running the entire length of one side. These V-rails serve as linear tracks for the V-wheels, securing the carriages to the gantry and allowing them to glide smoothly. The V-rails will face to the front (X) or inside (Y1 and Y2) of the machine. See **Figure 3-14**.

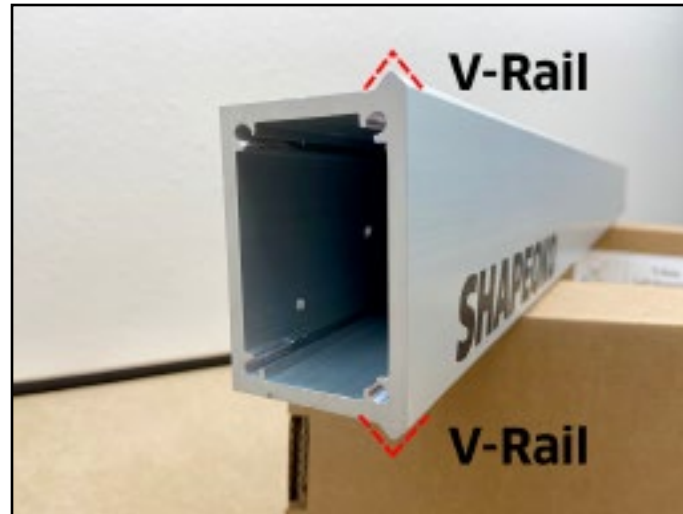

Figure 3-14

Position the X-Rail

1. Place the X-rail, with the decals facing the front, across the top of the two empty Y-Axis Left and Right Assembly boxes, as shown in **Figure 3-15**.

Install the Y1-Carriage

1. Identify the Y1-carriage. See **Figure 3-15**.
2. Use the 4mm hex key and four (4) M6x12mm button head cap screws to attach the Y1-carriage to the **LEFT** end of the X-rail as shown in **Figure 3-16**.

When properly attached, the motor body will be to the inside and behind the X-rail. The V-wheels, idlers, and motor pulley will be facing out as shown in **Figure 3-16**.

3. Snug the Y1-carriage to the X-rail, but do not fully tighten the screws.

PRO TIP: Screws going into the ends of the extrusion rails are prone to cross-threading. Pre-screw without the carriage to clear any debris from the threads. Screws should thread easily, with little resistance and without wobble. Also, when attaching the carriage, partially insert each of the four (4) screws before tightening. Then tighten each a little at a time in a cross-pattern.



Figure 3-15

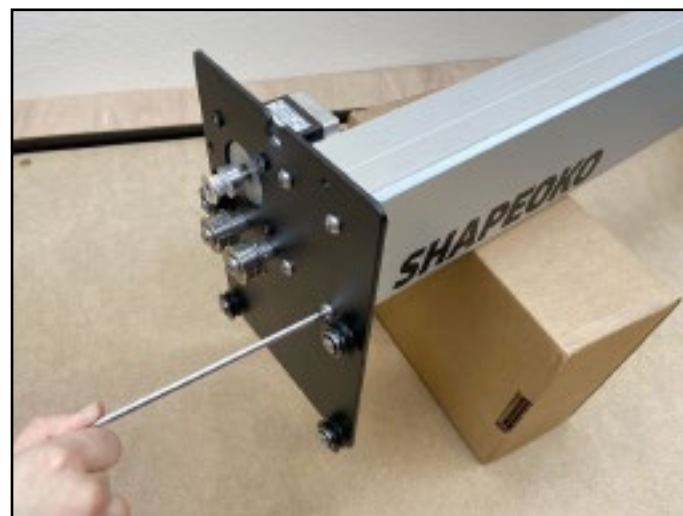

Figure 3-16

Install the Z-Plus

1. With the router mount facing front, line the four V-wheels up with the two V-rails, and slide the Z-Plus onto the open end of the X-rail. See **Figure 3-17**.

Pay special attention to all four V-wheels making sure they are seated properly on the V-rails. Once the Y2-carriage goes on, the Z-Plus is locked in place.

PRO TIP: Use masking tape to prevent the Z-Plus from rolling back and forth along the X-rail and hitting the other carriages.



Figure 3-17

Install the Y2-Carriage

1. Locate the Y2-carriage.
2. Use the 4mm hex key and four (4) M6x12mm button head cap screws to attach the Y2-carriage to the open end of the X-rail. See **Figure 3-18**.

When properly attached, the motor body will be to the inside and behind the X-rail. The V-wheels, idlers, and motor pulley will be facing out:

3. Snug the Y2-carriage to the X-rail, but do not fully tighten the screws.



Figure 3-18

Step 4 Gantry

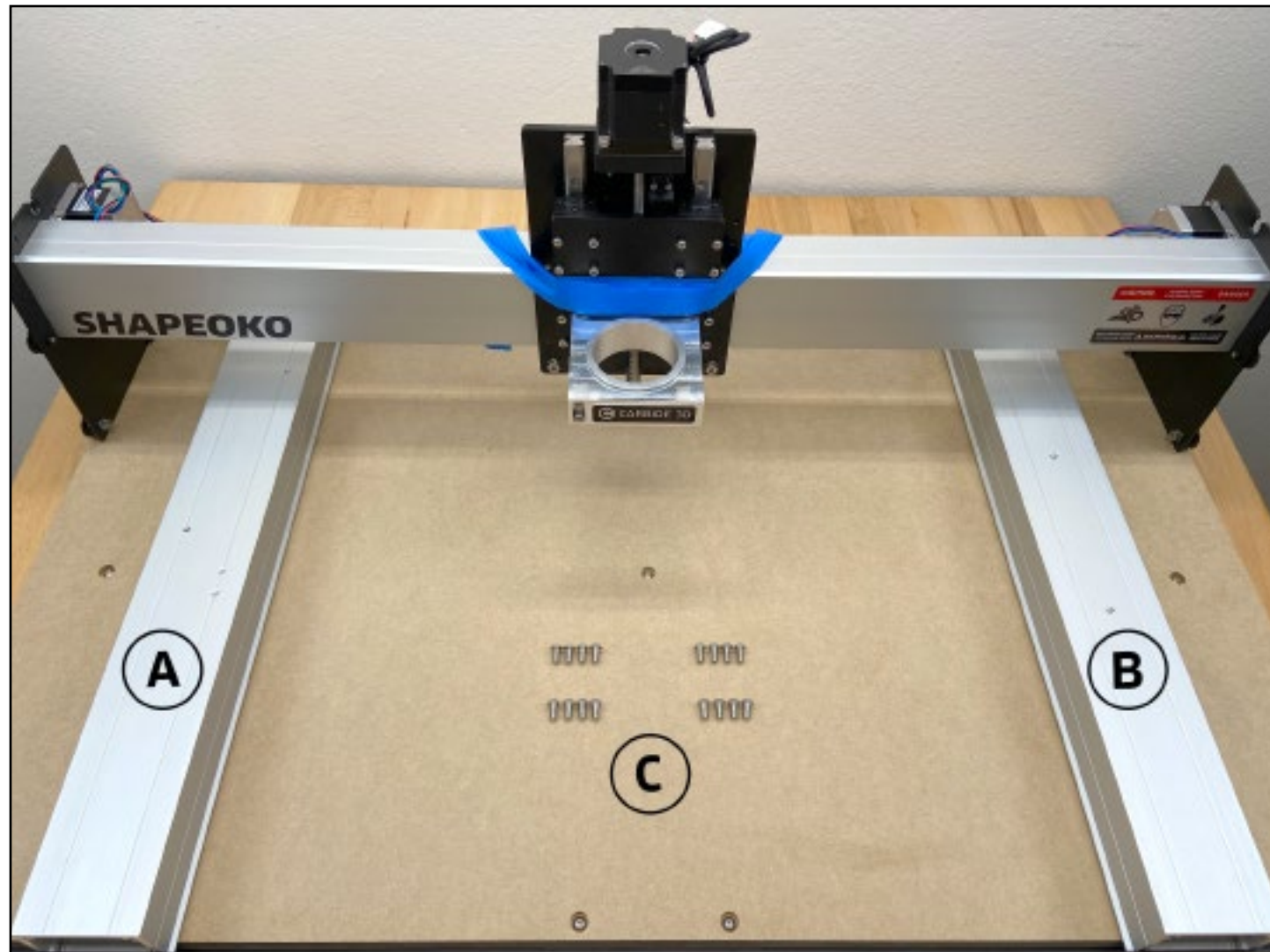
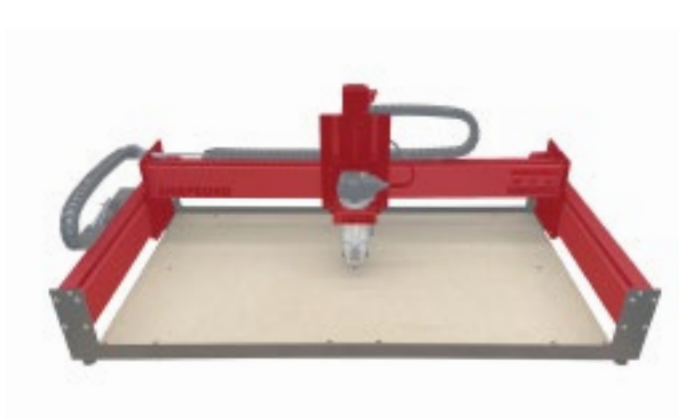

Figure 4-2

Required Components

See **Figure 4-2**:

Item	Description	Location	Qty
A	Y-Axis Left Aluminum Extrusion Rail (Y1-Rail)	N/A	1
C	M6 x 12mm Button Head Cap Screw	XL Final Assembly Box	8
B	Y-Axis Right Aluminum Extrusion Rail (Y2-Rail)	N/A	1
C	M6 x 12mm Button Head Cap Screw	XL Final Assembly Box	8

Required Tools

See **Figure 4-3**:

Item	Description	Qty
A	4mm Hex Key	1
B	10mm Wrench	1
C	Foam Packing Block (From the Two Y-Carriage Boxes)	2

Recommended Tools

See **Figure 4-3**:

Item	Description	Qty
D	10mm Combination Wrench	1

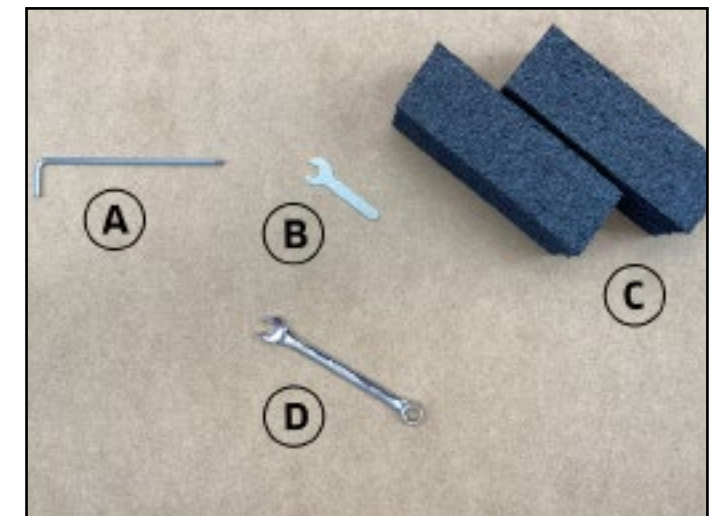

Figure 4-3

Assemble the Gantry

In this step, we'll be inserting the Y1- and Y2-rails into their carriages, then securing them to the baseframe to form the gantry.

Position the X-Rail

1. Position the X-rail with attached carriages diagonally across the baseframe. See **Figure 4-4**.



Figure 4-4

Insert the Y1-Rail

WARNING: Be sure to insert the Y1-rail right-side up: M6 holes towards the REAR and the two M4 holes along the TOP.

1. Slide the integrated V-rails of the Y1-rail between the four (4) V-wheels of the Y1-carriage. Center the rail with the carriage plate. See **Figure 4-5**.

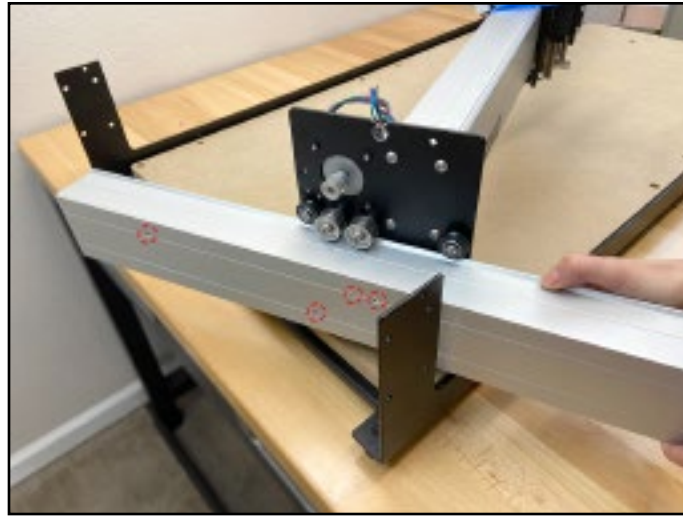

Figure 4-5

Insert the Y2-Rail

1. Slide the integrated V-rails of the Y2-rail between the four (4) V-wheels of the Y2-carriage. Center the rail with the carriage plate. See **Figure 4-6**.

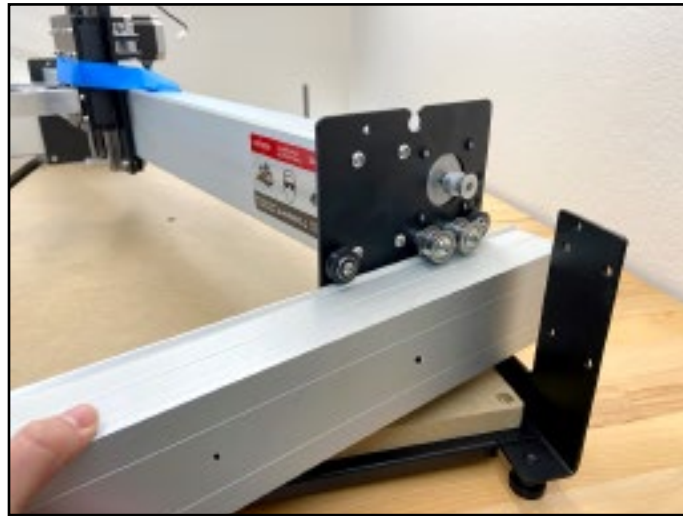

Figure 4-6

Secure the Gantry

Position the Gantry

PRO TIP: The gantry is large and awkward. During this step of the assembly, it may be helpful to have another set of hands.

1. Carefully lift, rotate, and lower the gantry so that the Y1- and Y2-rails are positioned between the front and rear endplates. The Y1-rail should be along the left, the Y2-rail along the right, and the Z-Plus facing front. See **Figure 4-7**.



Figure 4-7

Secure the Y1-Rail

The Y1- and Y2-rails will be raised into place one at a time. The first rail to be lifted (the Y1-rail) is loosely attached to the endplates with two screws, one front and one back. This creates a pivot point for rotating the Y2-rail up and into place.

1. Prop up the Y1-rail with the two foam packing blocks from the Y-Axis Left and Right Assembly boxes. See **Figure 4-8**.
2. Line up the Y1-rail screw holes with the front and rear endplate through-holes. See **Figure 4-8**.
3. Use the 4mm hex key and two (2) M6x12mm button head cap screws to loosely secure the Y1-rail to the **UPPER-INSIDE** mounting holes in the front and rear endplates. See **Figure 4-8**.

Keep these two (2) screws loose for now. They provide support and create the pivot point needed to rotate the Y2-rail into place.

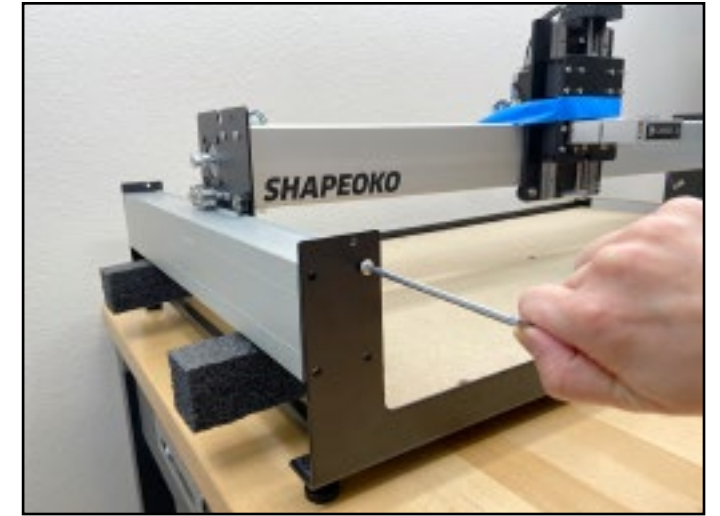

Figure 4-8

Secure the Y2-Rail

1. Remove the two foam blocks from under the Y1-rail and use them to prop up the Y2-rail.
2. Use the 4mm hex key and eight (8) M6x12mm button head cap screws to secure the Y2-rail to the front and rear endplates. See **Figure 4-9**.

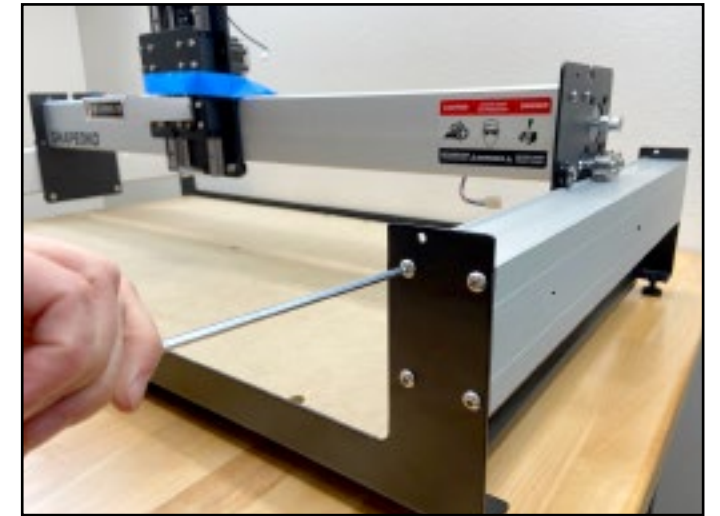

Figure 4-9

Complete Rail Assembly

1. Use the 4mm hex key and the remaining six (6) M6x12mm button head cap screws to secure the Y1-rail to the front and rear endplates.
2. Snug all sixteen (16) screws, leaving no gap between the rails and endplates, but do not fully tighten.

Tension the V-Wheels

1. Use the 10mm wrench to turn the two (2) eccentric nuts on each of the three carriages (Z-Plus, Y1, and Y2) clockwise until the V-wheels engage with the V-rails. See **Figure 4-10**.

Refer back to the eccentric nut information on page 18 and **Figures 3-4** and **3-5**, if needed.

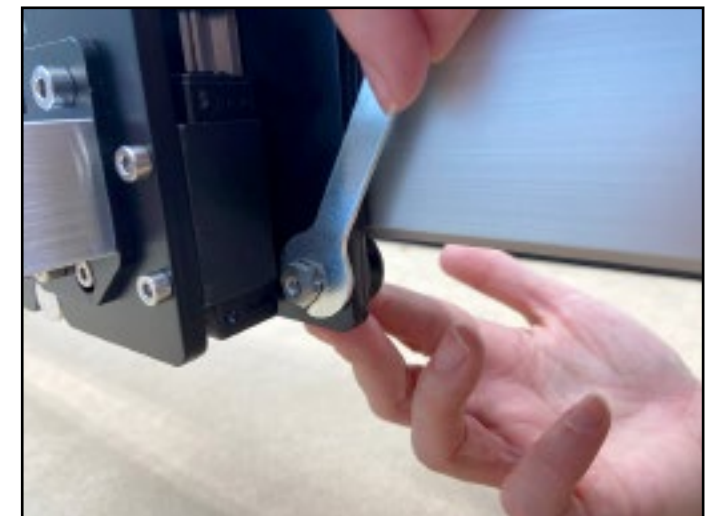

Figure 4-10

Step 5 Belting

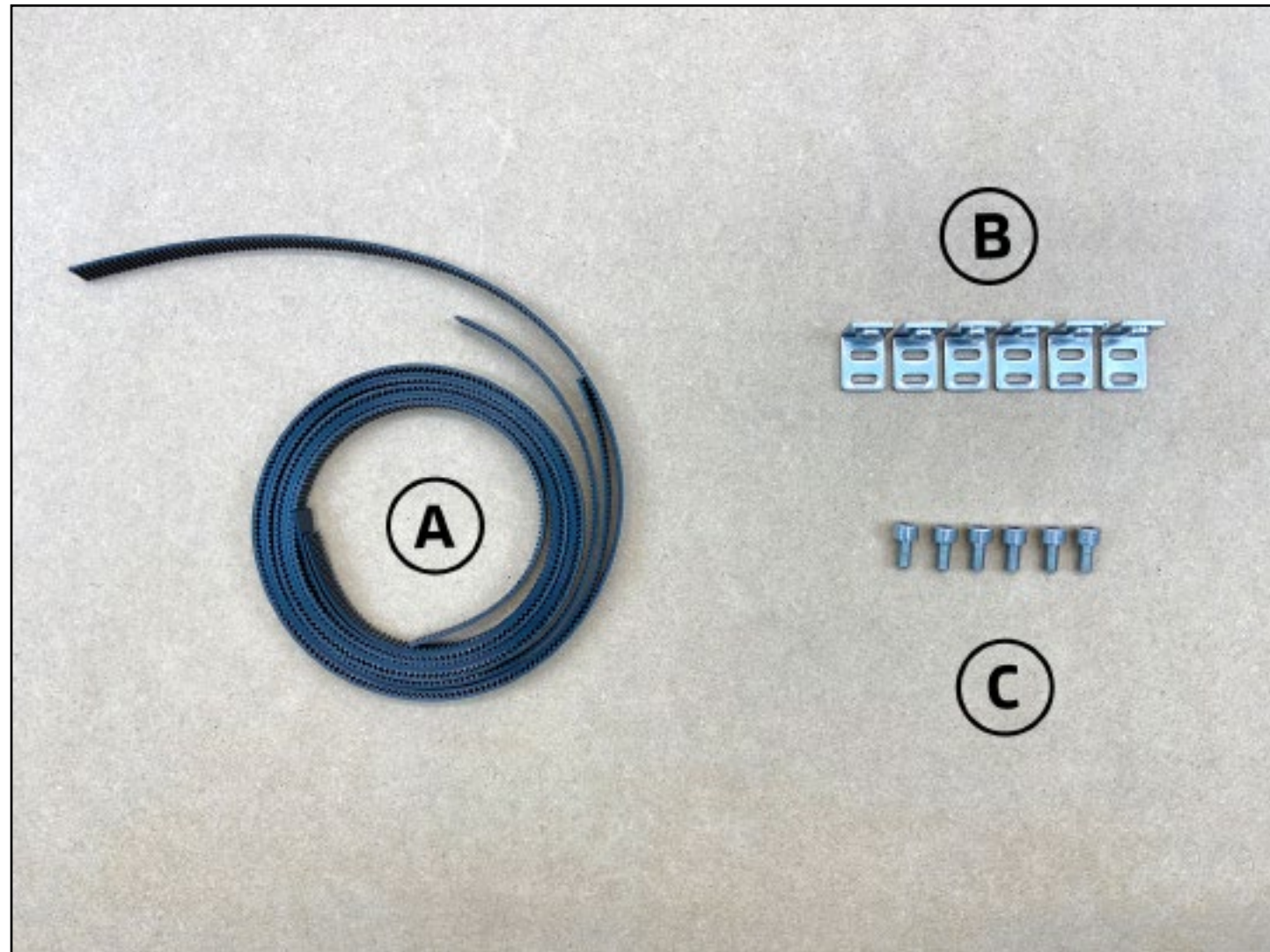

Figure 5-2

Required Components

See **Figure 5-2**:

Item	Description	Location	Qty
A	Steel-Core Toothed Belt	XL Final Assembly Box	3
B	Belt Clip	XL Final Assembly Box	6
C	M5 x 10mm Socket Head Cap Screw	XL Final Assembly Box	6

Required Tools

See **Figure 5-3**:

Item	Description	Qty
A	3 and 4mm Hex Key	2
B	Ruler or Tape Measure (not included)	1

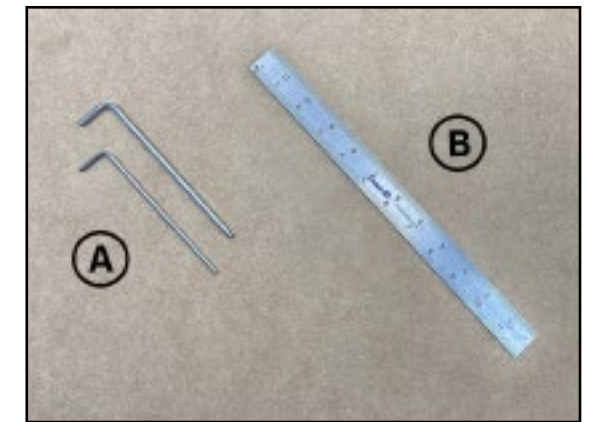

Figure 5-3

Belts and Belt Clips

Belts are secured to the rails using belt clips. Each belt clip has an PEM nut on the short leg and two parallel slots on the long leg. All six belt clips will attach to the ends of the three belts as follows. See **Figure 5-4**.

1. Thread 2 1/2 inches of belt through the outer slot of the belt clip with teeth facing toward the PEM nut.
2. Loop this end of belt down and through the inner slot of the clip. Pull the belt tight against the belt clip. The length of the short end should now be about 2 inches.
3. Bring the two sections of belt together. Interlock the teeth and extend the belt away from the PEM nut.



Figure 5-4

Install the X-Rail Belt

1. Attach a belt clip to one end of the longest belt. (Refer back to **Figure 5-4**.)
2. Set the belt clip on top of the X-rail next to the Y1-carriage. The belt should lay flat, teeth down, and extend along the X-rail towards the Z-Plus. Ensure the teeth of the bottom 2 inches of belt interlock with the top. See **Figure 5-5**.
3. Use the 4mm hex key and one (1) M5x10mm socket head cap screw to attach the belt clip to the Y1-carriage. Insert the screw from the **OUTSIDE** and tighten. See **Figure 5-5**.

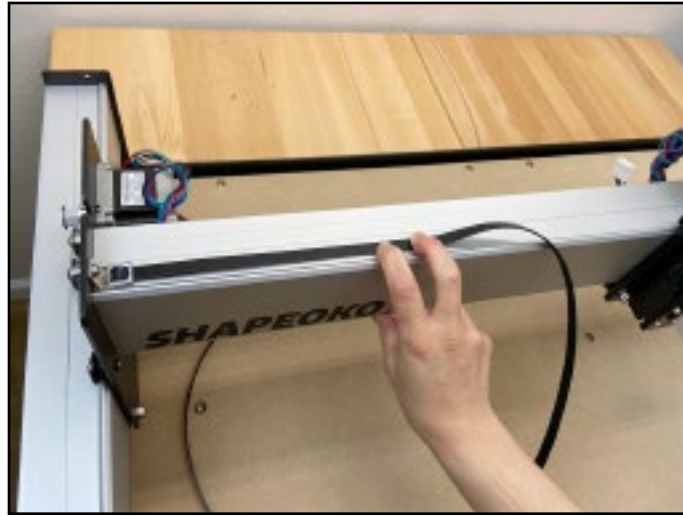

Figure 5-5

4. Feed the belt under the two idlers on the back of the Z-Plus. Make sure the belt does not twist and the teeth remain facing down all the way to the Y2-carriage. See **Figure 5-6**.

Do not attach the other end of the belt just yet.



Figure 5-6

5. Slide the 3mm hex key under the belt, between the two idlers. Use the hex key as a lever against the X-rail to push a loop of belt up between the two idlers as shown in **Figure 5-7**.

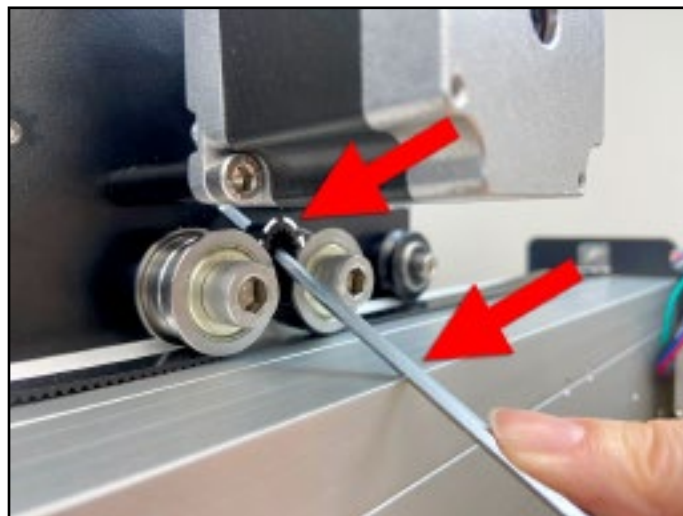

Figure 5-7

6. Use the 3mm hex key to reach in between the X-motor and carriage plate, hook the loop, and pull it up and out towards you. See **Figure 5-8**.

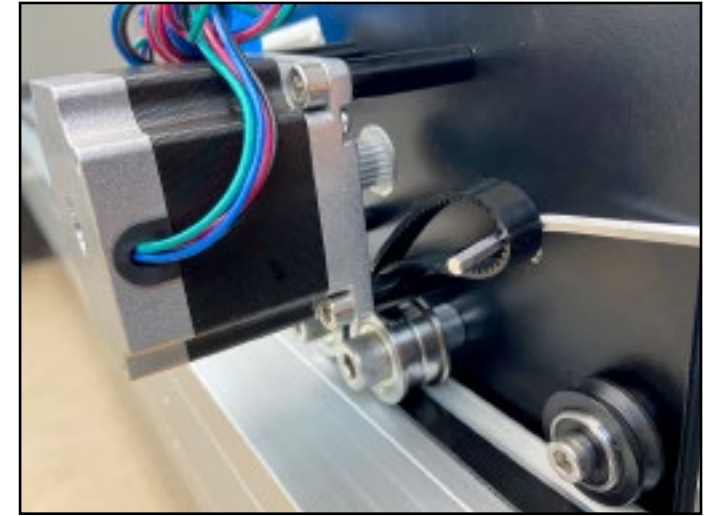

Figure 5-8

7. Make sure the belt has not twisted and the teeth are still facing down, then place the belt loop over the X-motor pulley. See **Figure 5-9**.
8. Very gently take the slack out of the belt by slowly pulling the free end toward the Y2-carriage.
9. Attach another belt clip to the free end of the belt. (Refer back to **Figure 5-4**.)

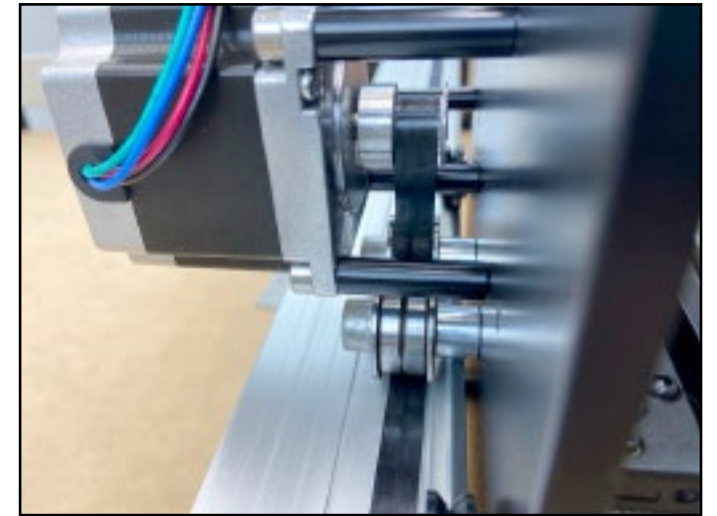

Figure 5-9

10. Adjust the amount of belt you feed through the second belt clip so that when it is laid flat against the X-rail (with the slack removed, but without stretching it), a 1/8-inch gap exists between the belt clip and the Y2-carriage. Ensure the teeth of the bottom few inches of belt interlock with the top. See **Figure 5-10**.



Figure 5-10

- Use the 4mm hex key and one (1) M5x10mm socket head cap screw to attach the belt clip to the Y2-carriage. Insert the screw from the **OUTSIDE** and tighten. Do not over tighten as this could bend the X-motor pulley. See **Figure 5-11**.

NOTE: The belt should be tight enough to snap against the X-rail when gently lifted.



Figure 5-11

Install the Y1-Rail Belt

- Attach a belt clip to one end of one of the two short belts. (Refer back to **Figure 5-4**.)
- Set the belt clip on top of the Y1-rail next to the front endplate. The belt should lay flat, teeth down, and extend along the Y1-rail towards the Y1-carriage. Ensure the teeth of the bottom 2 inches of belt interlock with the top. See **Figure 5-12**.
- Use the 4mm hex key and one (1) M5x10mm socket head cap screw to attach the belt clip to the front endplate. Insert the screw from the **FRONT** and tighten. See **Figure 5-12**.
- Feed the belt under the two idlers on the outside of the Y1-carriage. Make sure the belt does not twist and the teeth remain facing down all the way to the rear endplate. See **Figure 5-13**.

Do not attach the other end of the belt just yet.

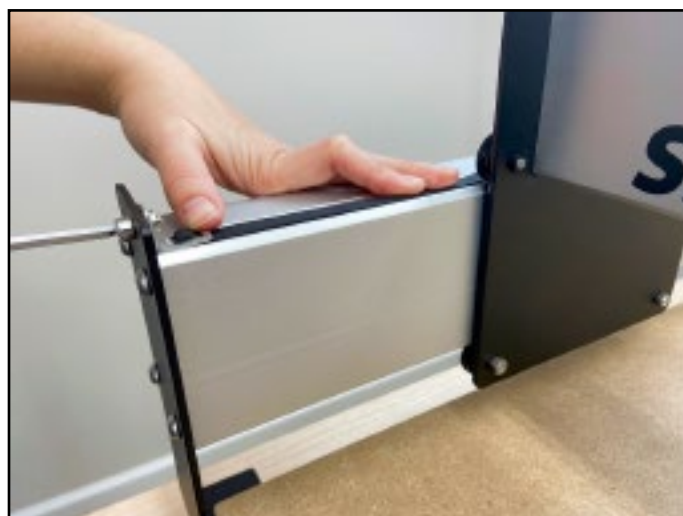

Figure 5-12

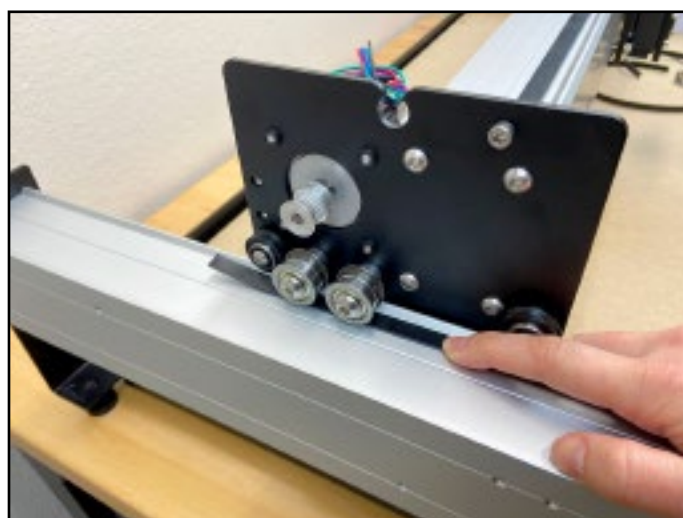

Figure 5-13

- Slide the 3mm hex key under the belt, between the two idlers, and use it as a lever against the X-rail to push a loop of belt up between the two idlers as shown in **Figure 5-14**.
- Use the 3mm hex key to hook the belt and pull it up between the two idlers.
- Make sure the belt has not twisted and the teeth are still facing down, then place the belt loop over the Y1-motor pulley. See **Figure 5-15**.
- Very gently take the slack out of the belt by slowly pulling the free end toward the rear endplate.
- Attach another belt clip to the free end of the belt. (Refer back to **Figure 5-4**.)
- Adjust the amount of belt you feed through the second belt clip so that when it is laid flat against the Y1-rail (with the slack removed, but without stretching it) a 1/8-inch gap exists between the belt clip and the rear endplate. Ensure the teeth of the bottom few inches of belt interlock with the top. See **Figure 5-16**.
- Use the 4mm hex key and one (1) M5x10mm socket head cap screw to attach the belt clip to the rear endplate. Insert the screw from the **BACK** and tighten. Do not over tighten as this could bend the Y1-motor pulley.

NOTE: The belt should be tight enough to snap against the Y1-rail when gently lifted.

Install the Y2-Rail Belt

PRO TIP: The Y2-belt installation is a mirror image of the Y1-belt process.

- Install the remaining belt on the Y2-rail, following steps 1-11 of the "Install the Y1-Rail Belt" section above.

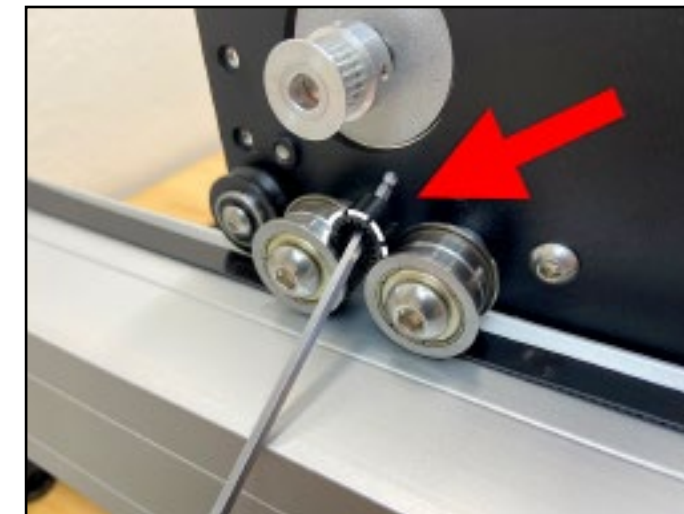

Figure 5-14

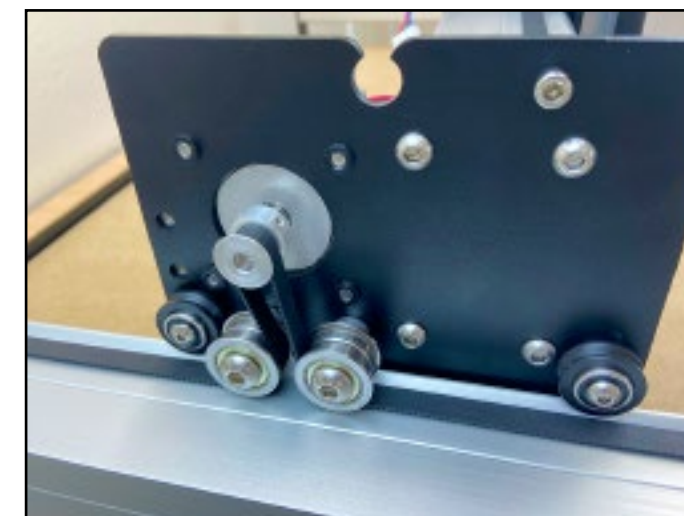

Figure 5-15



Figure 5-16

Step 6 Drag Chain

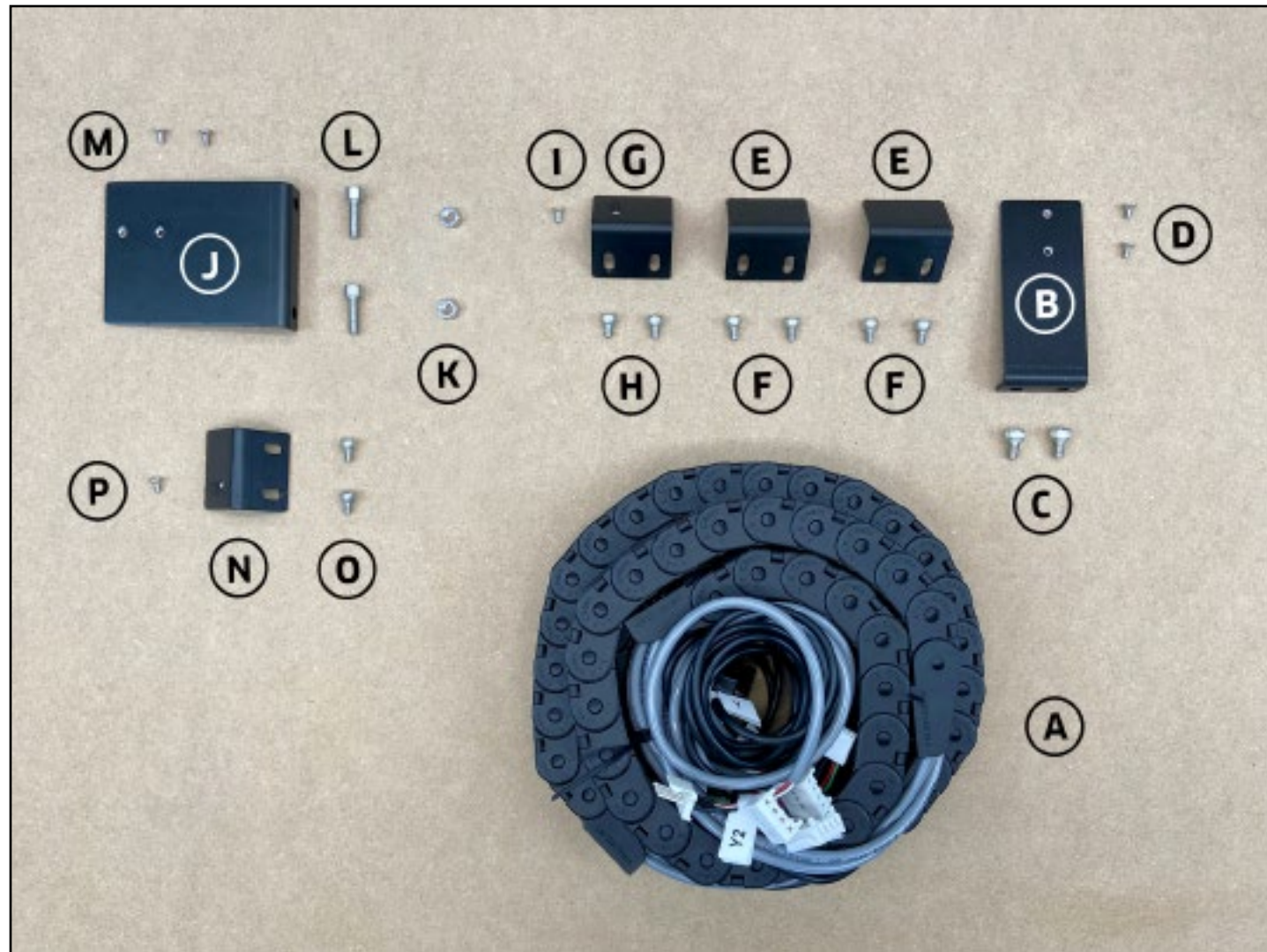

Figure 6-2

Required Components

See **Figure 6-2**:

Item	Description	Location	Qty
A	Wiring Harness (X-Axis Drag Chain & Y-Axis Drag Chain)	XL Wiring Harness Box	1
*** ** X-AXIS DRAG CHAIN SUPPORT SYSTEM *** **			
B	X-Axis Drag Chain Head Bracket	XL Wiring Harness Box	1
C	M5 x 8mm Socket Head Cap Screw	XL Wiring Harness Box	2
D	M3 x 4mm Flat Head Screw	XL Wiring Harness Box	2
E	Drag Chain Middle Bracket	XL Wiring Harness Box	2
F	M4 x 6mm Socket Head Cap Screw	XL Wiring Harness Box	4
G	Drag Chain Tail Bracket	XL Wiring Harness Box	1
H	M4 x 6mm Socket Head Cap Screw	XL Wiring Harness Box	2
I	M3 x 4mm Flat Head Screw	XL Wiring Harness Box	1
*** ** Y-AXIS DRAG CHAIN SUPPORT SYSTEM *** **			
J	Y-Axis Drag Chain Head Bracket	XL Wiring Harness Box	1
K	M5 Nut	XL Wiring Harness Box	2
L	M5 x 16mm Socket Head Cap Screw	XL Wiring Harness Box	2
M	M3 x 4mm Flat Head Screw	XL Wiring Harness Box	2
N	Drag Chain Tail Bracket	XL Wiring Harness Box	1
O	M4 x 6mm Socket Head Cap Screw	XL Wiring Harness Box	2
P	M3 x 4mm Flat Head Screw	XL Wiring Harness Box	1

Required Tools

See **Figure 6-3**:

Item	Description	Qty
A	2, 3, and 4mm Hex Key	3
B	8mm Wrench	1

Recommended Tools

See **Figure 6-3**:

Item	Description	Qty
C	8mm Combination Wrench	1

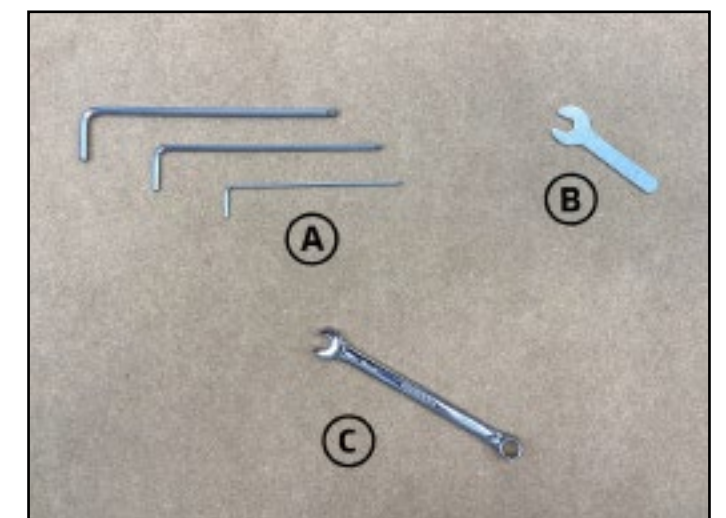

Figure 6-3

Install Drag Chain Supports

There are three types of drag chain supports: head, middle, and tail brackets. The longer head brackets are unique. However, the two (2) tail brackets and two (2) middle brackets respectively are identical and interchangeable. Tail brackets are identified by their single PEM nut. All brackets install flange down. The tail and middle brackets attach to the X- and Y1-rails via the horizontal sets of M4 screw holes.

Install the X-Axis Supports

1. Gather the X-Axis drag chain head bracket (the narrower of the two head brackets), a tail bracket (single PEM nut) and two (2) middle brackets (no PEM nut).
2. Use the 3mm hex key and two (2) M5x8mm socket head cap screws to secure the head bracket to the back of the Z-Plus, just above the X-motor. See **Figure 6-4**.
3. Use the 3mm hex key and two (2) M4x6mm socket head cap screws to attach one (1) tail bracket (single PEM nut) to the back of the X-rail closest to the Y1-carriage. See **Figure 6-5**.
4. Use the 3mm hex key and four (4) M4x6mm socket head cap screws to attach the two (2) middle brackets (no PEM nut) to the back of the X-rail in the remaining two sets of M4 screw holes, closest to the Y2-carriage. See **Figure 6-5**.

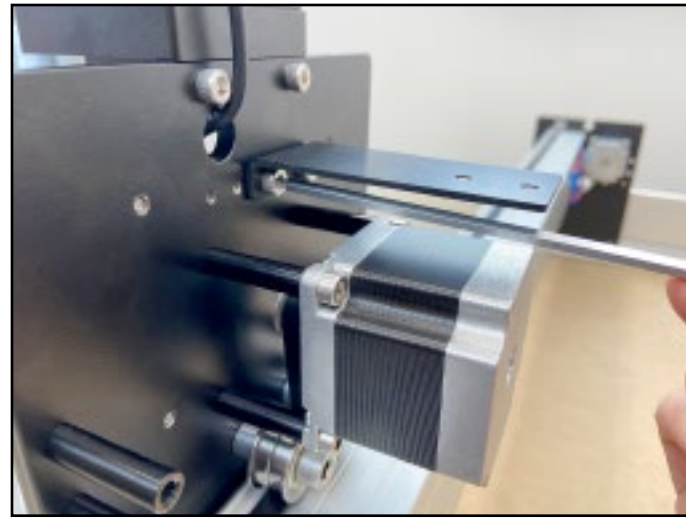

Figure 6-4

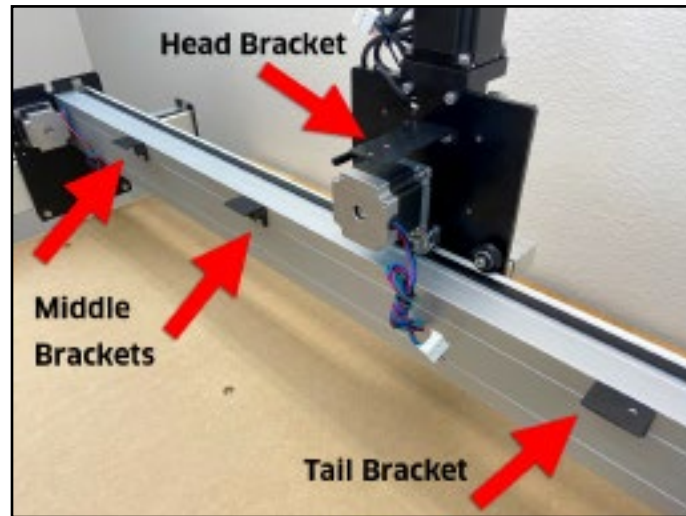

Figure 6-5

Install the Y-Axis Supports

NOTE: To accommodate the smaller Shapeoko 3 machines, the Y1-motor is mounted to the Y1-carriage with four (4) M5x10mm socket head cap screws. However, to attach the Y-Axis drag chain head bracket to the Shapeoko XL, the top two (2) motor-mount screws will need to be replaced by two (2) longer M5x16mm socket head cap screws. Once replaced, the shorter screws will no longer be needed. See **Figure 6-6**.



Figure 6-6

1. Use the 4mm hex key to remove the top two (2) M5x10mm socket head cap screws mounting the Y1-motor to the Y1-carriage plate and replace them with the longer two (2) M5x16mm socket head cap screws. See **Figure 6-6**.

Once replaced, you will be able to see the screws protruding through the Y1-carriage as shown in **Figure 6-6**.

2. Gather the remaining head and tail bracket.
3. Use the 8mm wrench and two (2) M5 nuts to secure the head bracket to the two protruding M5x16mm socket head cap screws on the Y1-carriage above the Y1-motor pulley. See **Figure 6-7**.
4. Use the 3mm hex key and two (2) M4x6mm socket head cap screws to attach the tail bracket (single PEM nut) to the outside of the Y1-rail. See **Figure 6-8**.



Figure 6-7

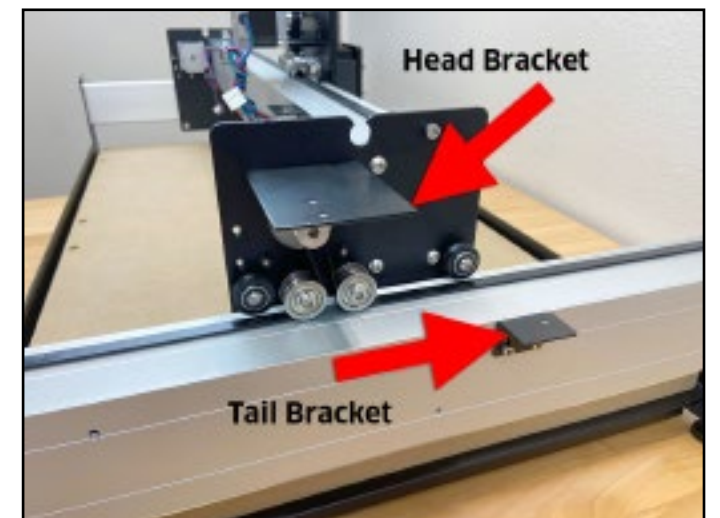

Figure 6-8

Install the Wiring Harness

WARNING: Drag chains will only curl in one direction. Do not force the drag chain to bend; if it doesn't curl easily, simply turn it over and try again.

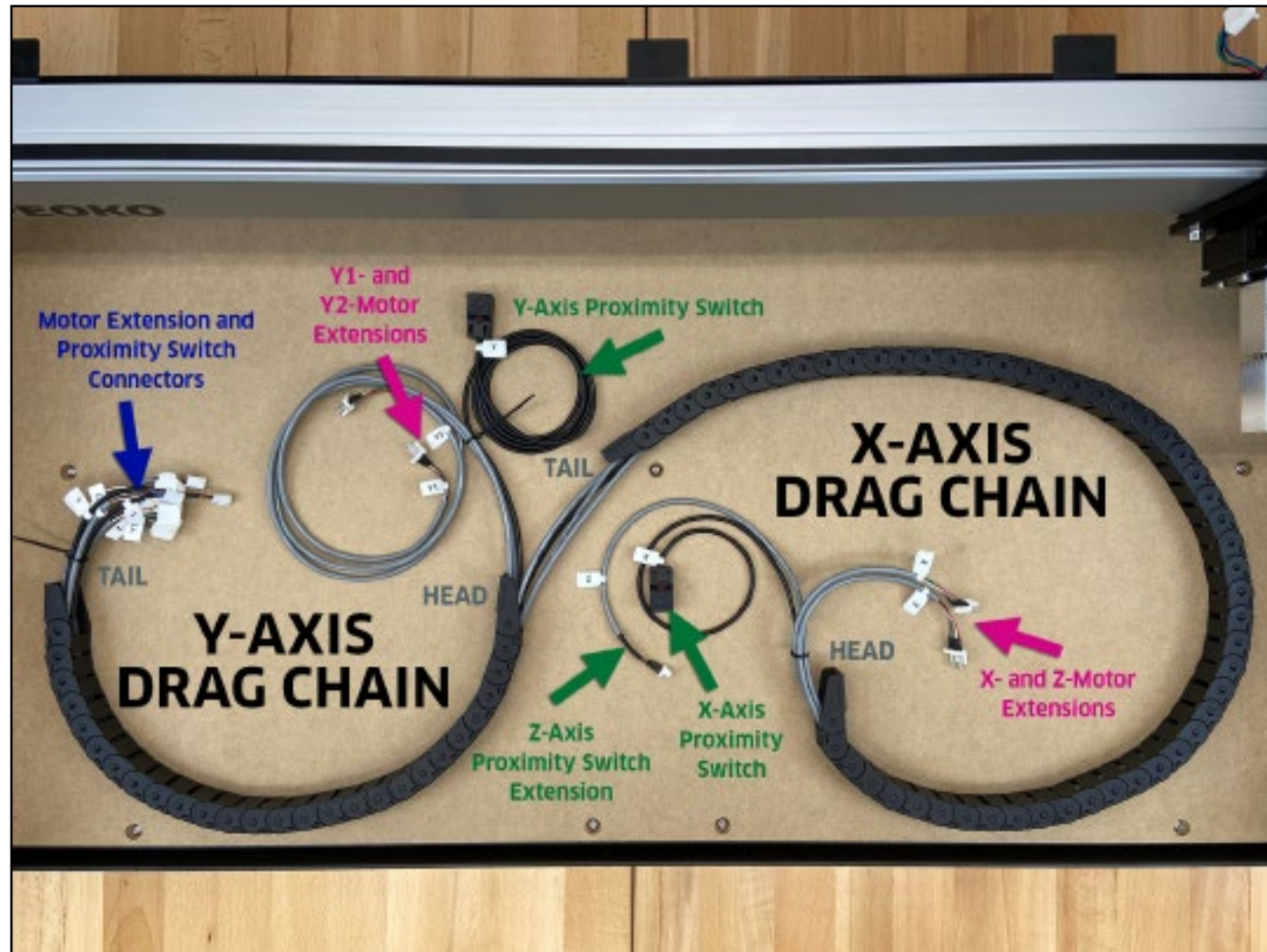

Figure 6-9

THE WIRING HARNESS

The complete wiring harness consists of the Y-Axis drag chain, X-Axis drag chain, four stepper motor extension cables, two proximity switches with cables, and one proximity switch extension cable. It's often referred to simply as "the drag chain." Take a minute to familiarize yourself with all of its components described below and shown in **Figure 6-9**.

Y-Axis Drag Chain

The Y-Axis drag chain rests on the Y1-rail and serves as a conduit for all seven of the extension cables as they make their way from the Carbide Motion board to the rest of the machine. It has 28 chain links; its tail is next to the Carbide Motion board enclosure and head on the Y1-carriage.

X-Axis Drag Chain

The X-Axis drag chain rests on the X-rail and serves as a conduit for the X- and Z- cables as they make their way to the Z-Plus. It has 54 chain links; its tail is next to the Y1-carriage and head on the Z-Plus.

Stepper Motor Extension Cables

There are four stepper motors, two for the Y-axis and one each for the X- and Z-Axis. The Y1- and Y2-motors work in tandem to drive the gantry forward and backward. The X-motor moves it left and right. The Z-motor moves it up and down. They are each connected to the Carbide Motion board by four gray 4-pin extension cables, pre-installed in the wiring harness.

Proximity Switches and Cables

There are three inductive proximity switches, one each for the X-, Y-, and Z-Axis. They set the origin for the machine and determine the limits of the work area. The X- and Y-switches, attached to the ends of black 3-pin extension cables, are labeled and routed through the drag chains. The Z-Axis switch comes pre-installed on the front of the Z-Plus. It connects to a separate gray 3-pin extension cable that is routed through the drag chains.

Install the Y-Axis Drag Chain

1. Unroll and lay out the wiring harness on the baseframe as shown in **Figure 6-9**.
2. Move the X-rail all the way to the **FRONT**, and move the Z-Plus 8-10 inches from the Y2-carriage as shown in **Figure 6-10**.

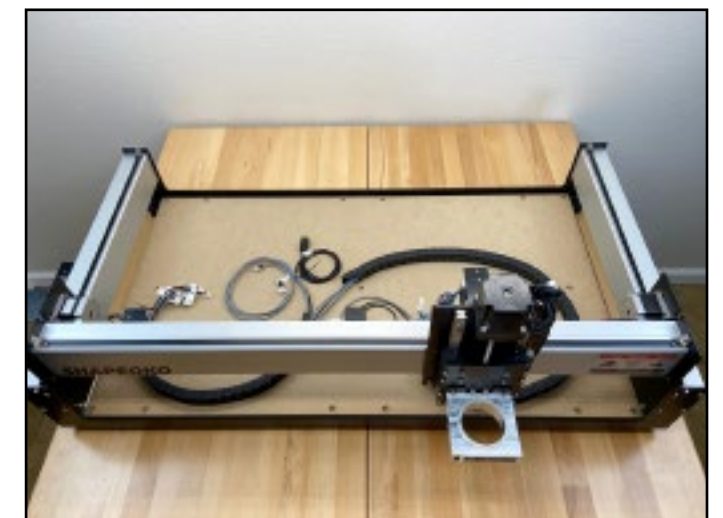

Figure 6-10

3. Reach over the X-rail and lift the tail of the Y-Axis drag chain with your left hand and the head with your right, as shown in **Figure 6-11**.



Figure 6-11

4. Rest the tail flat on the tail bracket, and the head on the Y-Axis drag chain head bracket on the **OUTSIDE** of the Y1-carriage. See **Figure 6-12**.



Figure 6-12

5. Use the 2mm hex key and two (2) M3x4mm flat head screws to secure the Y-Axis drag chain to the head bracket as shown in **Figure 6-13**.

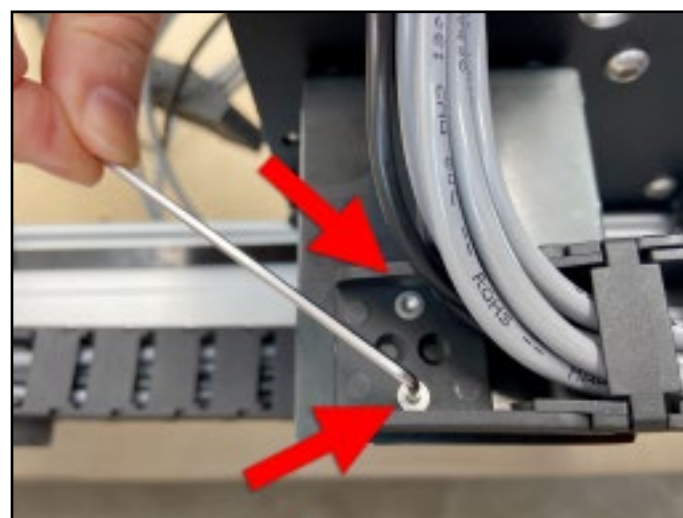

Figure 6-13

6. Use the 2mm hex key and one (1) M3x4mm flat head screw to secure the tail of the Y-Axis drag chain to the single PEM nut in the tail bracket. Use the center through-hole furthest from the end of the drag chain as shown in **Figure 6-14**.

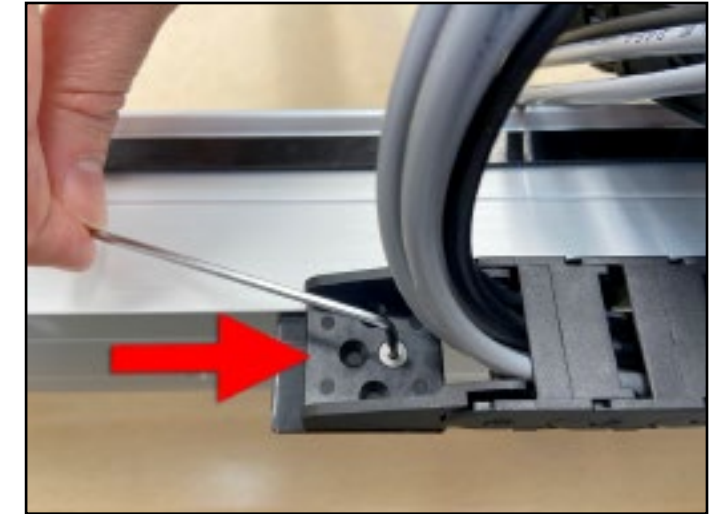

Figure 6-14

Install the X-Axis Drag Chain

1. Reach over the X-rail and lift the X-Axis drag chain. Lay it flat along the length of the X-rail with the head curling upwards near the Y2-carriage.
2. Curl the head of the drag chain up and towards the Z-Plus and rest it on top of the X-Axis drag chain head bracket. See **Figure 6-15**.
3. Use the 2mm hex key and two (2) M3x4mm flat head screws to secure the X-Axis drag chain to the head bracket. See **Figure 6-15**.
4. Use the 2mm hex key and one (1) M3x4mm flat head screw to secure the tail of the X-Axis drag chain to the single PEM nut in the tail bracket. Use the center through-hole closest to the end of the drag chain. See **Figure 6-16**.

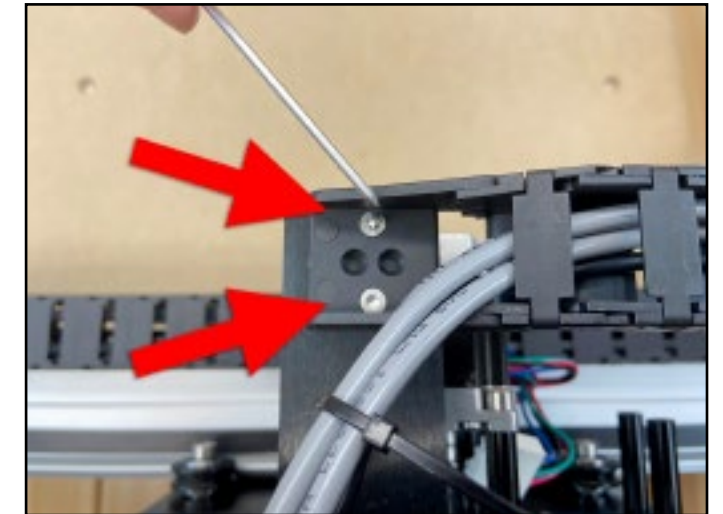

Figure 6-15

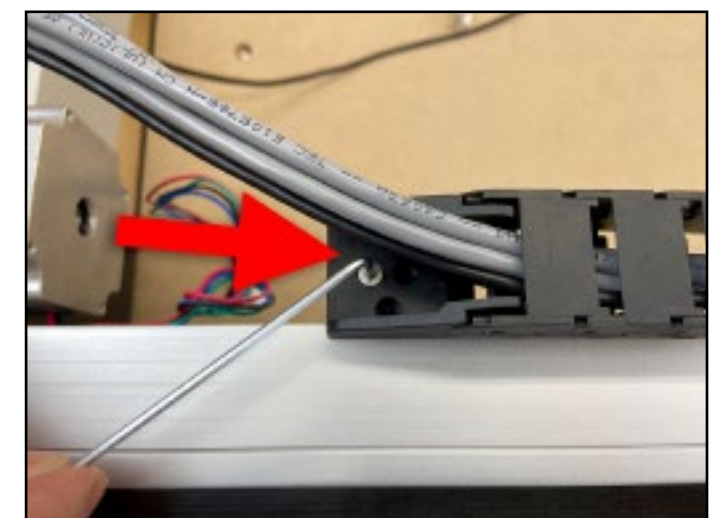

Figure 6-16

Step 7

Proximity Switches

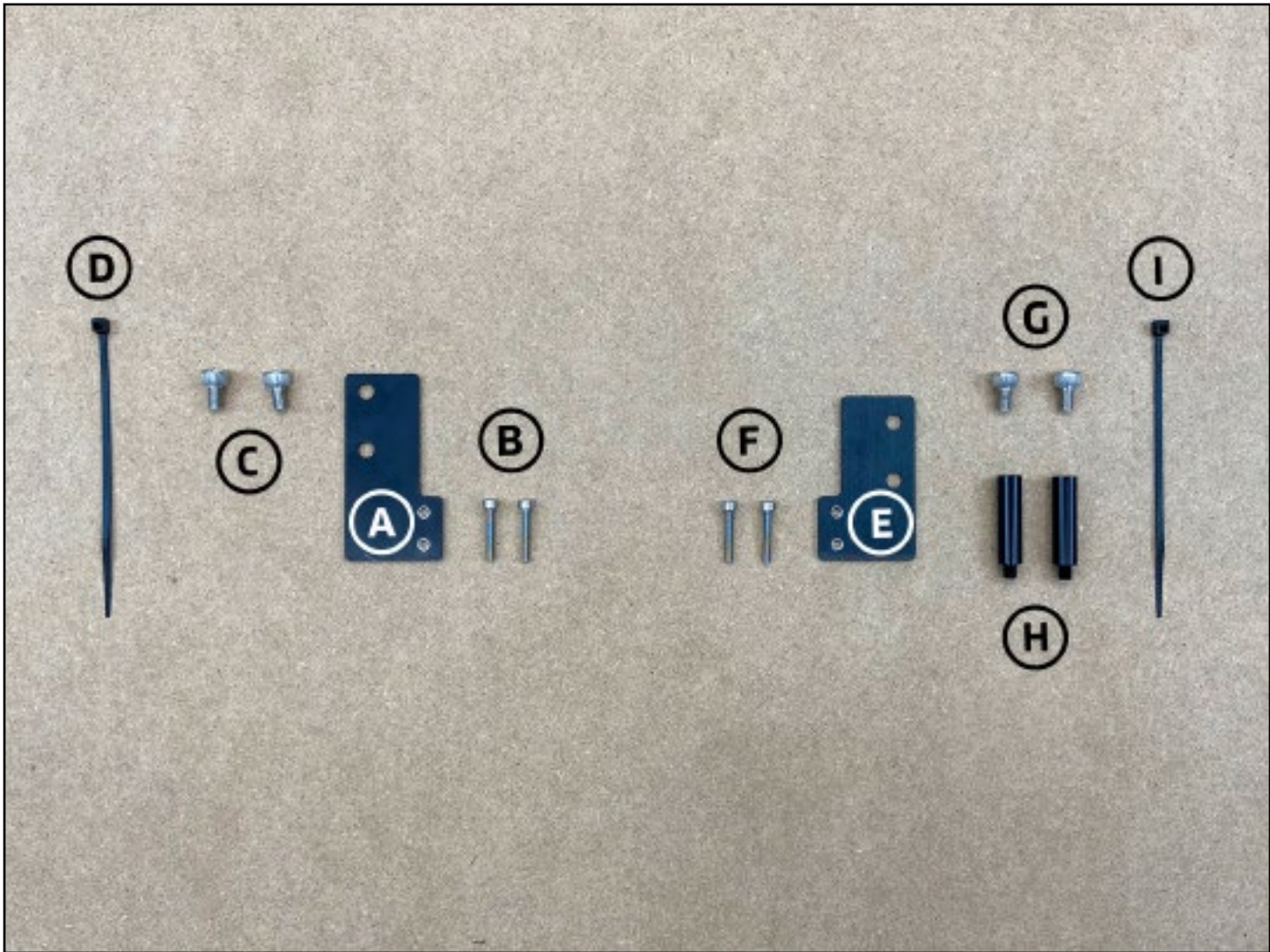
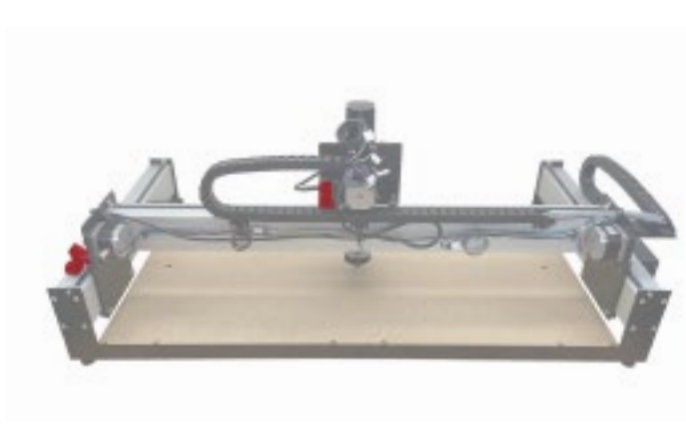

Figure 7-2

Required Components

See **Figure 7-2**:

Item	Description	Location	Qty
A	X-Axis Proximity Switch Plate	XL Wiring Harness Box	1
B	M3 x 18mm Socket Head Cap Screw	XL Wiring Harness Box	2
C	M5 x 8mm Socket Head Cap Screw	XL Wiring Harness Box	2
D	Cable tie	XL Wiring Harness Box	1
E	Y-Axis Proximity Switch Plate	XL Wiring Harness Box	1
F	M3 x 18mm Socket Head Cap Screw	XL Wiring Harness Box	2
G	M5 x 8mm Socket Head Cap Screw	XL Wiring Harness Box	2
H	Male to Female 30mm Standoff	XL Wiring Harness Box	2
I	Cable tie	XL Wiring Harness Box	1

Required Tools

See **Figure 7-3**:

Item	Description	Qty
A	2.5 and 4mm Hex Key	2

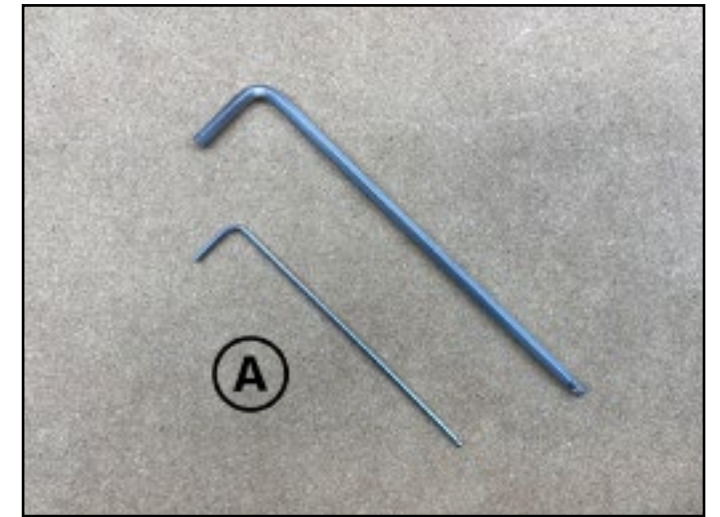

Figure 7-3

Install the Proximity Switches

The Shapeoko XL includes three inductive proximity switches. The Z-Axis proximity switch is pre-installed on the front of the Z-Plus. The X- and Y-Axis proximity switches are pre-installed in the wiring harness. See **Figure 7-4**.

Install the X-Axis Proximity Switch

The X-Axis proximity switch exits the X-Axis drag chain behind the Z-Plus. It attaches to the X-Axis proximity switch mounting plate then installs on the **BACK** of the Z-Plus.

1. Locate the X-Axis proximity switch mounting plate, the taller of the two plates, and the proximity switch labeled "X."
2. Align the switch and plate, with the switch facing left and the plate's two PEM nuts in the **BOTTOM-RIGHT** corner. Flush the face of the switch with the edge of the plate. See **Figure 7-5**.
3. Use the 2.5mm hex key and two (2) M3x18mm socket head cap screws to attach the switch to the plate. Make sure the front edge of the proximity switch and plate stay flush. See **Figure 7-5**.
4. Route the proximity switch cable and mounting plate behind, then through the loop of the X-Axis drag chain. See **Figure 7-6**.
5. Use the 4mm hex key and two (2) M5x8mm socket head cap screws to install the mounting plate to the two 30mm standoffs at the rear of the Z-Plus. See **Figure 7-6**.
6. Use one (1) cable tie to secure the proximity switch cable to the upper standoff. See **Figure 7-6**.

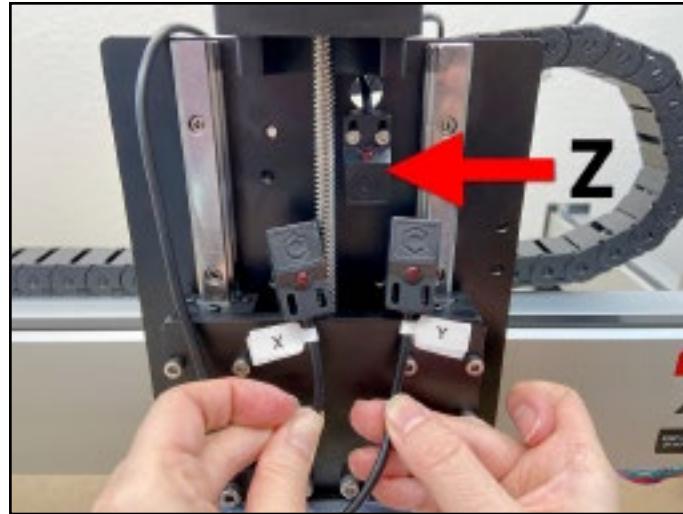

Figure 7-4

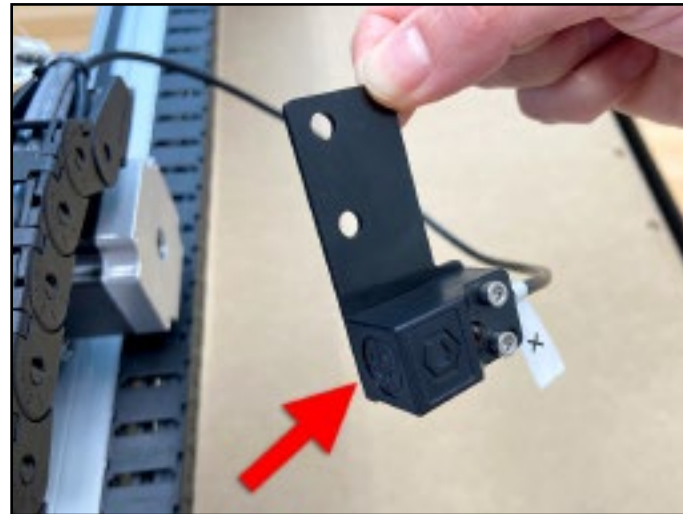

Figure 7-5

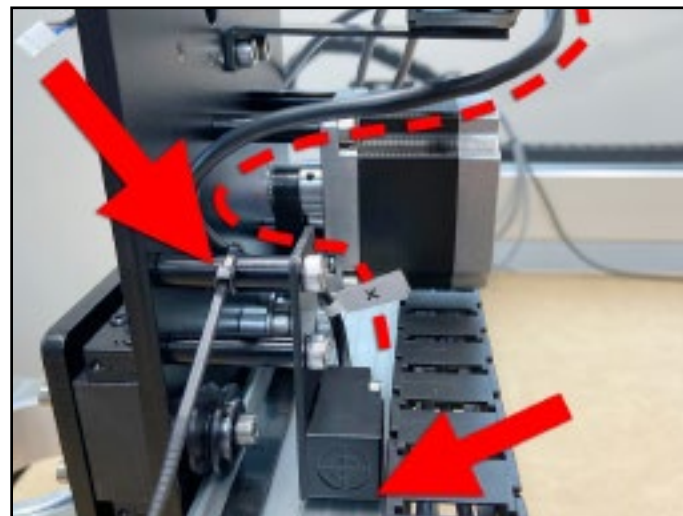

Figure 7-6

Install the Y-Axis Proximity Switch

The Y-Axis proximity switch exits the Y-Axis drag chain at the Y1-carriage. It attaches to the Y-Axis switch plate then mounts to the **OUTSIDE** of the Y2-carriage.

1. Locate the Y-Axis proximity switch mounting plate and the proximity switch labeled "Y."
2. Align the switch and plate, with the switch facing right and the plate's two PEM nuts in the **BOTTOM-LEFT** corner. Flush the face of the switch with the edge of the plate. See **Figure 7-7**.
3. Use the 2.5mm hex key and two (2) M3x18mm socket head cap screws to attach the switch to the plate. Make sure the front edge of the proximity switch and plate stay flush. See **Figure 7-7**.
4. Install the two (2) male to female 30mm standoffs to the **OUTSIDE** of the Y2-carriage. See **Figure 7-8**.
5. Route the proximity switch cable and mounting plate all the way across the machine, behind the X-rail, to the **OUTSIDE** of the Y2-carriage.
6. Use the 4mm hex key and two (2) M5x8mm socket head cap screws to install the mounting plate to the two 30mm standoffs on the **OUTSIDE** of the Y2-rail with the switch to the outside of the plate and facing the rear. See **Figure 7-9**.
7. Use one (1) cable tie to secure the proximity switch cable to the upper standoff. See **Figure 7-9**.

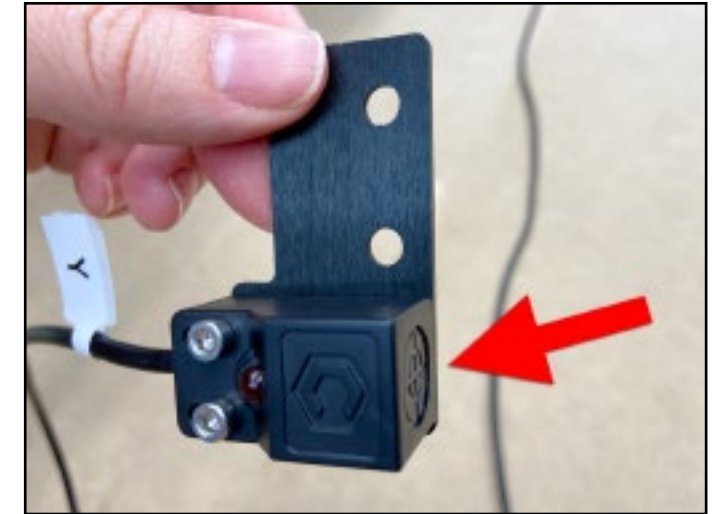

Figure 7-7

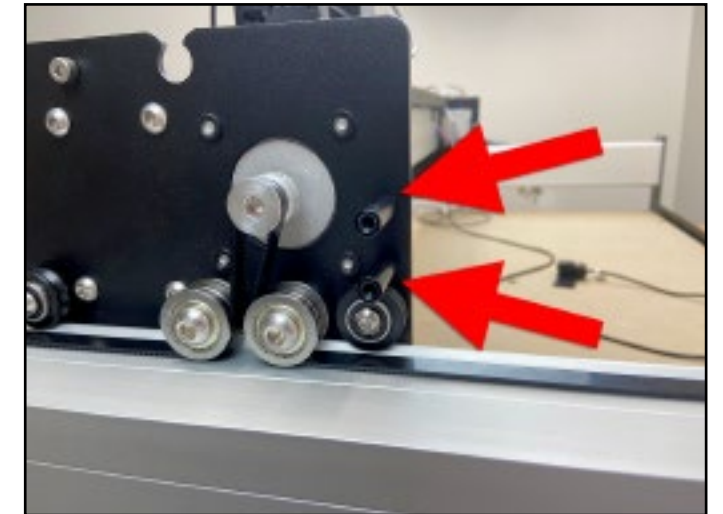

Figure 7-8

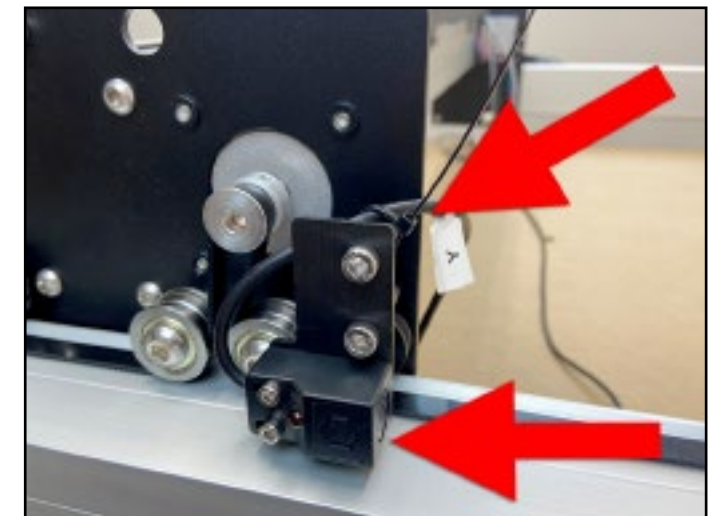

Figure 7-9

Step 8

Wiring

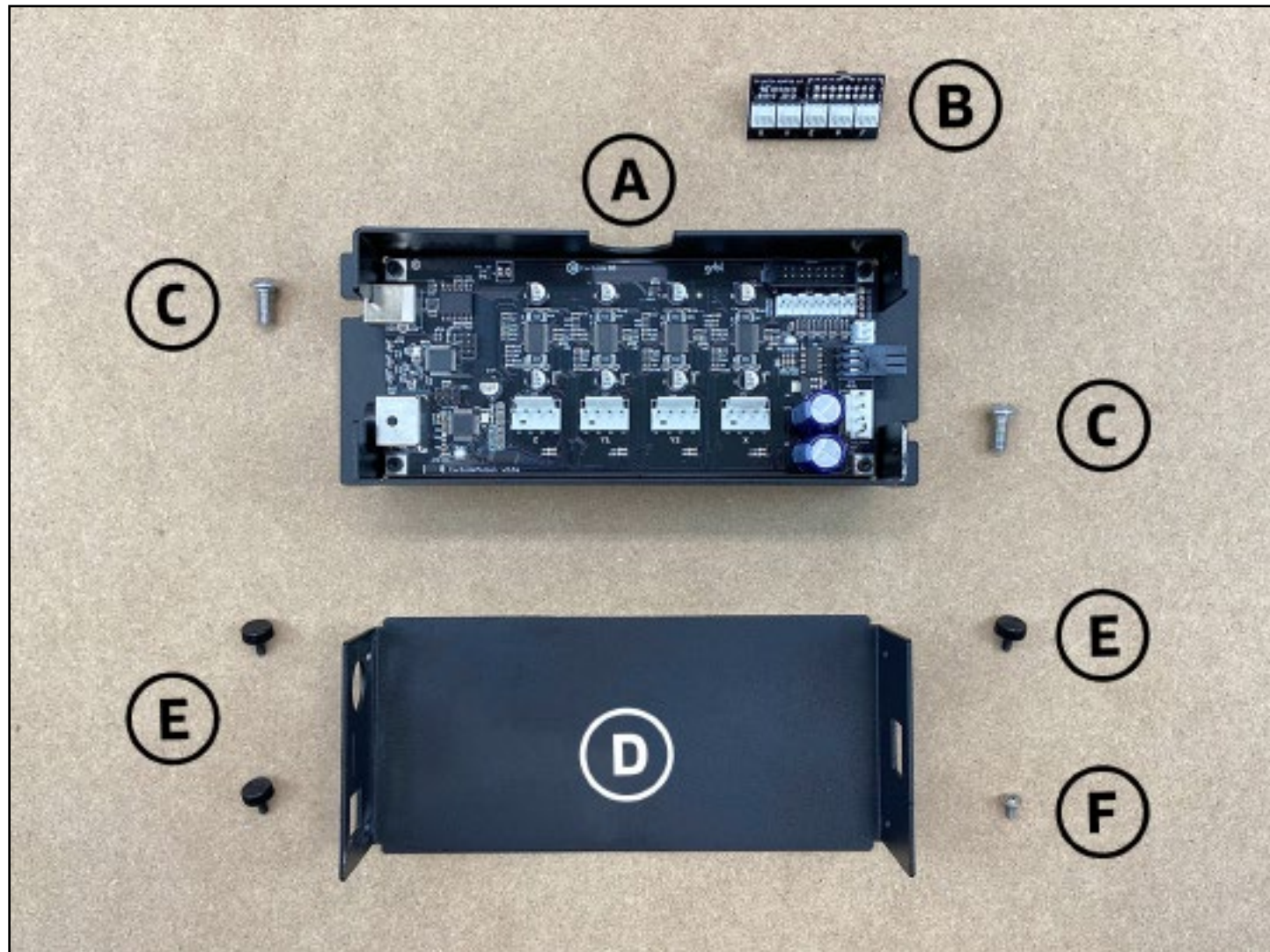
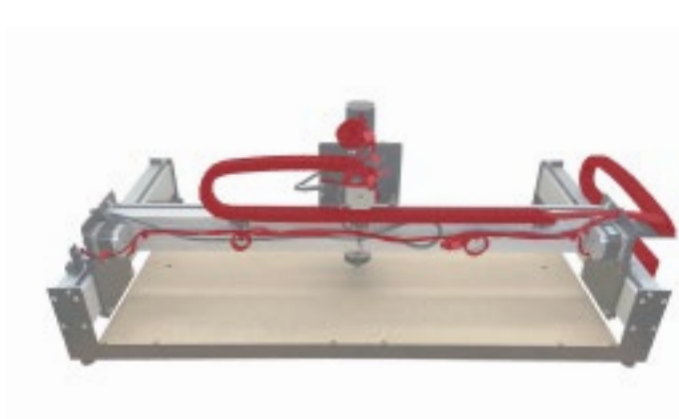

Figure 8-2

Required Components

See **Figure 8-2**:

Item	Description	Location	Qty
A	Carbide Motion Board and Enclosure	XL Final Assembly Box	1
B	PCB Riser Board (Adapter)	XL Final Assembly Box	1
C	M6 x 12mm Button Head Cap Screw	XL Final Assembly Box	2
D	Enclosure Cover	XL Final Assembly Box	1
E	Thumb Screw	XL Final Assembly Box	3
F	M3 x 6mm Flanged Button Head Cap Screw	XL Final Assembly Box	1

Required Tools

See **Figure 8-3**:

Item	Description	Qty
A	2 and 4mm Hex Key	2

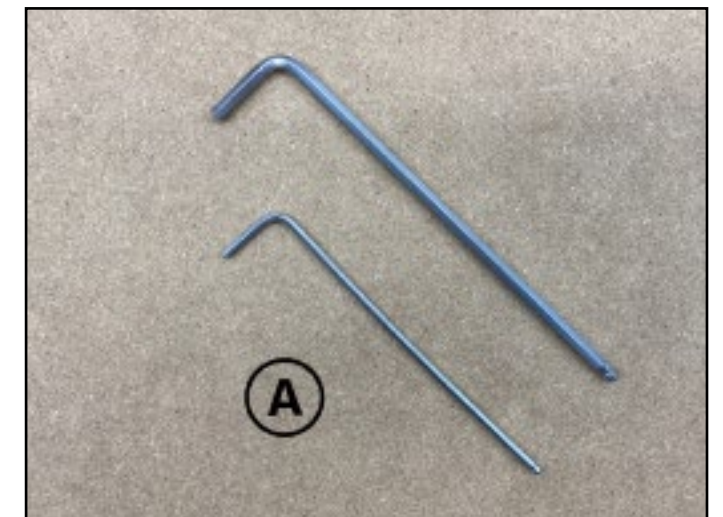

Figure 8-3

WARNING: The connections on the 3-pin (proximity switch cables) and 4-pin (motor extension cables) connectors are polarized and can only be connected one way. Do not force a connection. If you encounter resistance, ensure you have the correct orientation. See **Figure 8-4**.

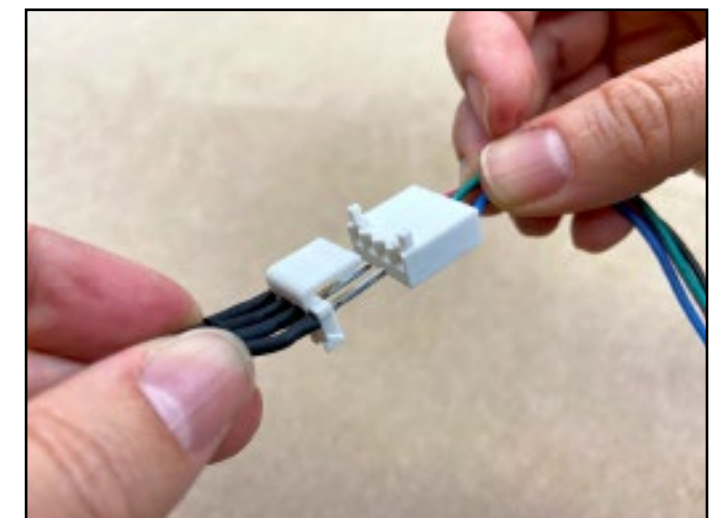

Figure 8-4

Install the PCB Riser Board

The PCB riser board is required to connect the polarized 3-pin inductive proximity switches to the Carbide Motion board.

WARNING: When removing the enclosure cover, pry open from the USB/power end first, then open like a book to avoid damaging the protruding Bitrunner adapter. See **Figure 8-5**.

1. Remove the enclosure cover.

Inside are two (2) M6x12mm button head cap screws. Set them aside.

2. Plug the PCB riser board into the open pins in the **TOP-RIGHT** corner of the Carbide Motion board. See **Figures 8-5** and **8-6**.

Mount the Enclosure

1. Position the enclosure on the **OUTSIDE** of the Y1-rail, with the USB and power ports facing the **REAR** of the machine.
2. Use the 4mm hex key and the two (2) M6x12mm button head cap screws to mount the enclosure. See **Figure 8-6**.

Wire the Carbide Motion Board

Wire Proximity Switches

1. Plug the 3-pin proximity switch extension cables labeled “X,” “Y,” and “Z” into their respective ports on the PCB riser board. Be sure to match the labels on the cables with those on the board. The “P,” and “F” ports to the right remain empty. See **Figure 8-7**.

Wire Stepper Motors

1. Plug the 4-pin stepper motor extension cables labeled “Z,” “Y1,” “Y2,” and “X” into their respective ports along the bottom of the Carbide Motion board. Match the labels on the cables with those on the board. See **Figure 8-7**.

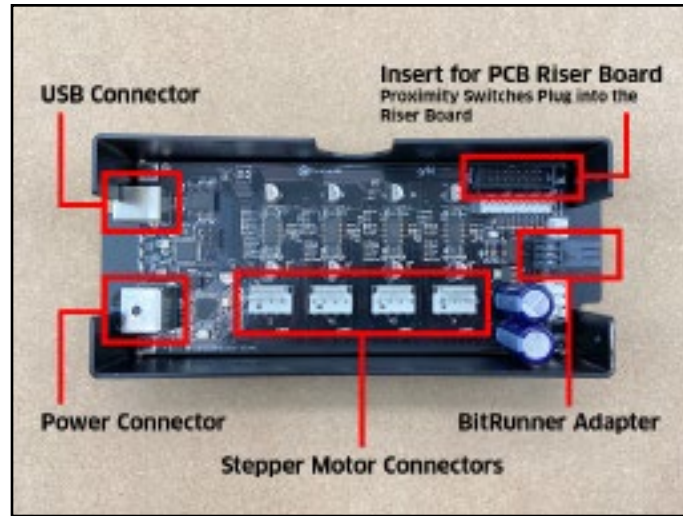

Figure 8-5



Figure 8-6

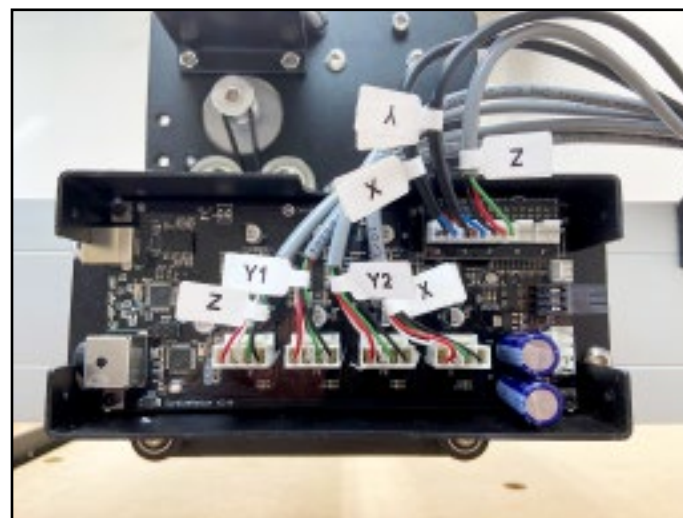

Figure 8-7

2. Bundle all seven cables together and direct them into the notch at the top of the enclosure.
3. Re-install the enclosure cover.

Connect Extension Cables

Connect Z-Axis Proximity Switch

1. Locate the short black Z-Axis proximity switch cable exiting the back of the Z-Plus and the long gray 3-pin extension cable labeled “Z” exiting the head of the X-Axis drag chain.
2. Align and connect the two cables. See **Figure 8-8**.

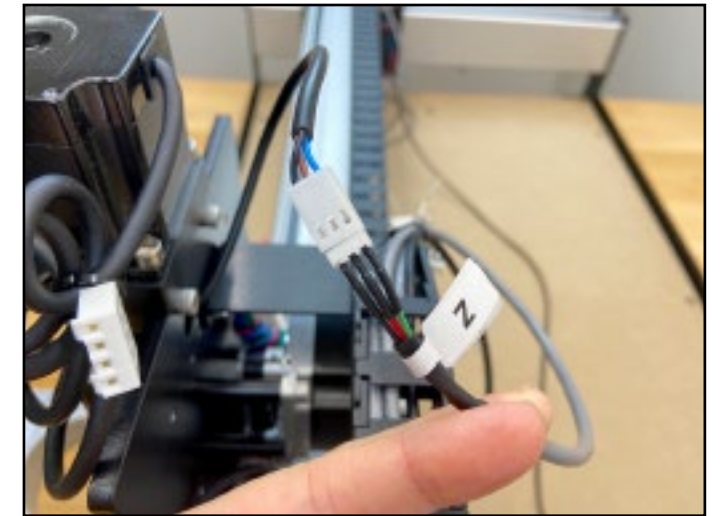

Figure 8-8

Connect X- and Z-Stepper Motors

It is not necessary to unravel X- and Z-motor leads before connecting them to the extension cables.

1. Connect the X- and Z-motor leads to the labeled gray 4-pin extension cables. See **Figure 8-9**.

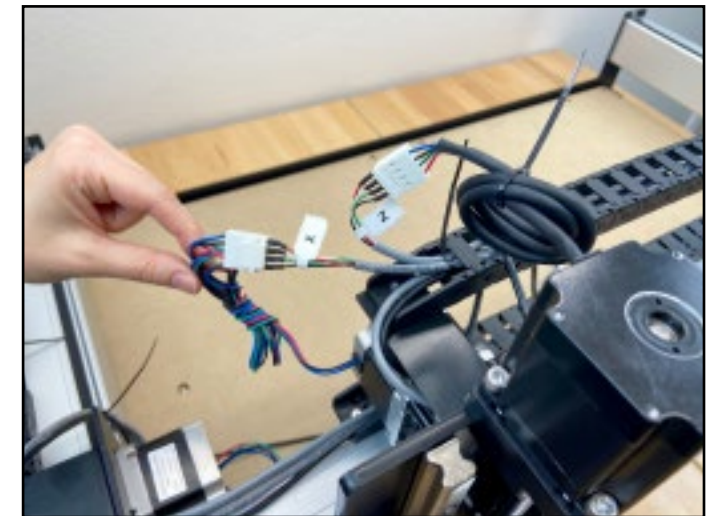

Figure 8-9

Connect Y1- and Y2-Stepper Motors

Unravel the Y1- and Y2-motor leads before connecting them to the extension cables.

2. Connect the Y1- and Y2-stepper motor leads to the labeled gray 4-pin extension cables. See **Figure 8-10**.

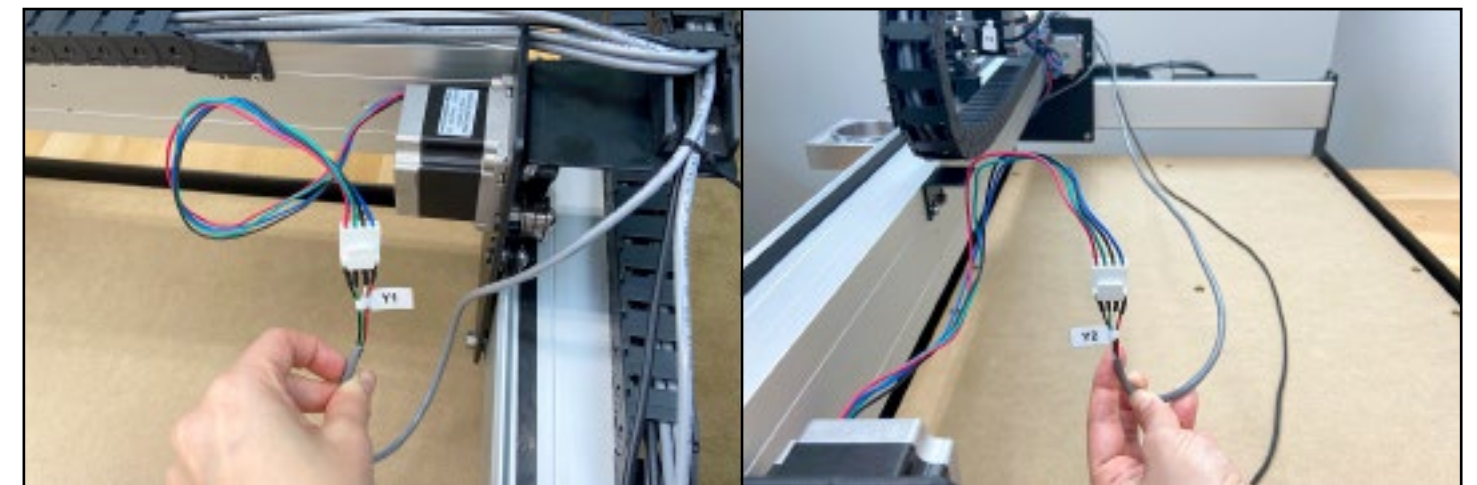

Figure 8-10

Step 9 Cleanup

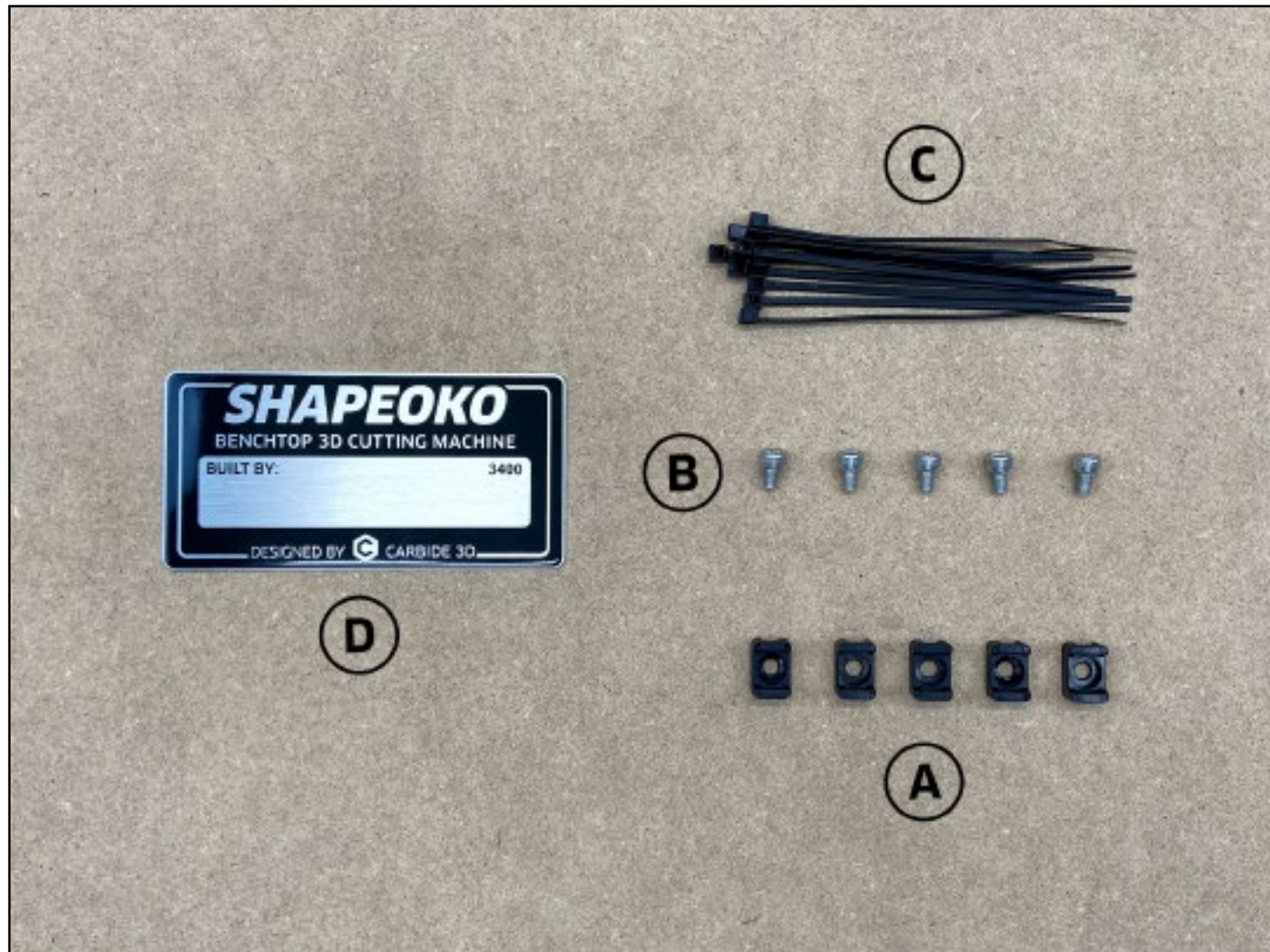
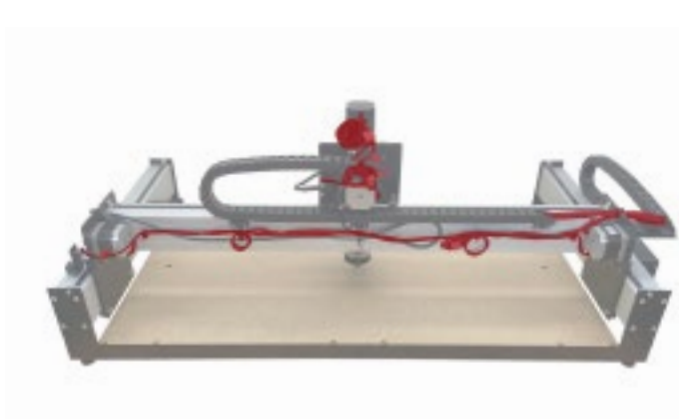

Figure 9-2

Required Components

See **Figure 9-2**:

Item	Description	Location	Qty
A	Cable Tie Mounts	XL Wiring Harness Box	5
B	M4 x 6mm Socket Head Cap Screw	XL Wiring Harness Box	5
C	Cable Ties	XL Wiring Harness Box	11
D	Shapeoko Decal	XL Final Assembly Box	1

Required Tools

See **Figure 9-3**:

Item	Description	Qty
A	3mm Hex Key	1
B	Flush Cut Pliers or Scissors (not included)	1
C	Permanent Marker	1

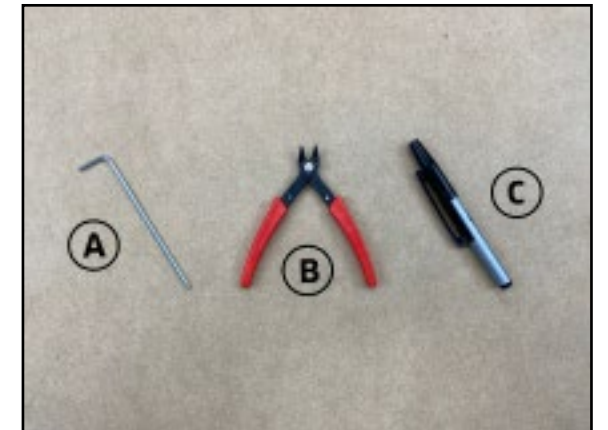

Figure 9-3

Secure Loose Cables

Secure Cables at the Y1-Carriage

All seven (7) cables crossing the Y1-carriage, are bundled into the circular cutout at the top of the carriage.

1. Insert the cables one at a time, beginning with the three Y-cables and followed by the four X- and Z-cables. See **Figure 9-4**.

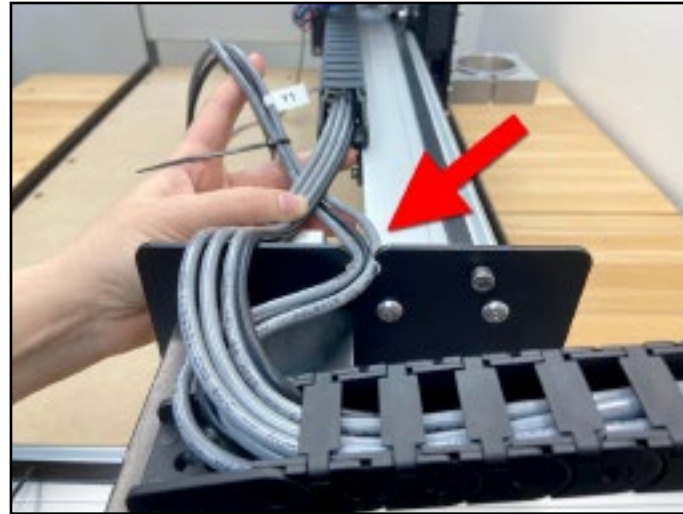

Figure 9-4

2. Use two (2) cable ties, one on each side of the cutout, to secure the cables in place as shown in **Figure 9-5**.

PRO TIP: Neatly securing cables is more of an art than a science. Important things to note are: It's ok to loop cables in tight circles, but avoid kinks. Give the cables slack next to motors, switches, and plugs, and ensure they won't get snagged on a corner or sucked into the router or a motor.

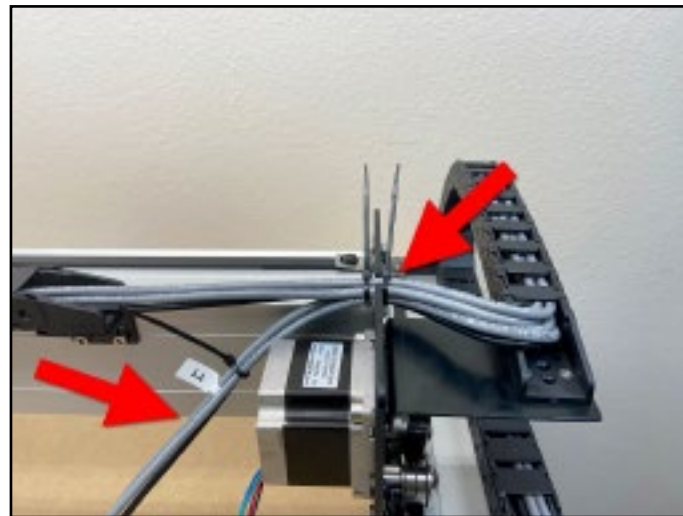

Figure 9-5

Secure Cables Along the X-Rail

All the Y-cables are secured to the back side of the X-rail using cable tie mounts and cable ties.

1. Use the 3mm hex key and one (1) M4x6mm socket head cap screw to attach each of the five (5) cable tie mounts to the upper M4 screw holes across the back of the X-rail. Position the cable tie mounts vertically. See **Figure 9-6**.



Figure 9-6

2. Use five (5) cable ties to secure the cables to the five (5) cable tie mounts. See **Figure 9-7**. The cable tie mounts have two attachment points. When securing cables to the center cable tie mount, only use the upper attachment point. The lower one is reserved for the router's power cord.
3. Trim the ends of all the cable ties with a pair of flush cut pliers or scissors (not included).

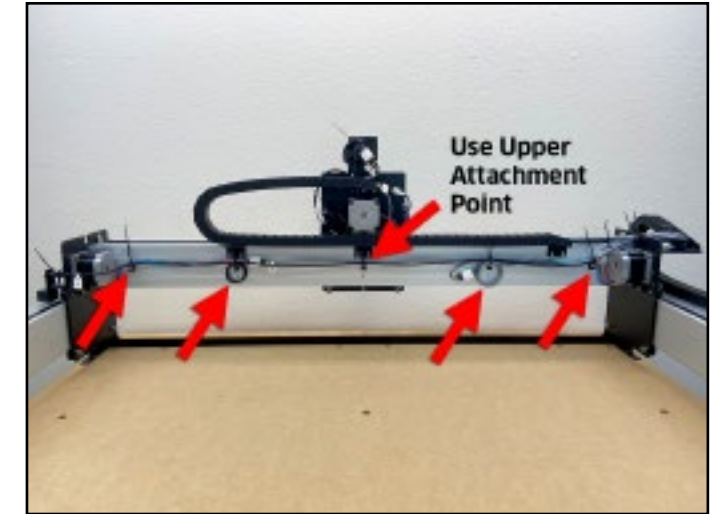

Figure 9-7

Secure Cables at the Z-Plus

1. Neatly bundle the two X-cables together behind the X-motor. See **Figure 9-8**.
2. Use one cable tie to secure the X-cables to the first link of the drag chain and a second to keep the bundle tidy.
3. Neatly bundle the two Z-cables together behind the Z-motor. See **Figure 9-8**.
4. Use two (2) cable ties to secure the Z cables.
5. Use flush cut pliers or scissors (not included) to trim the ends of all the cable ties.

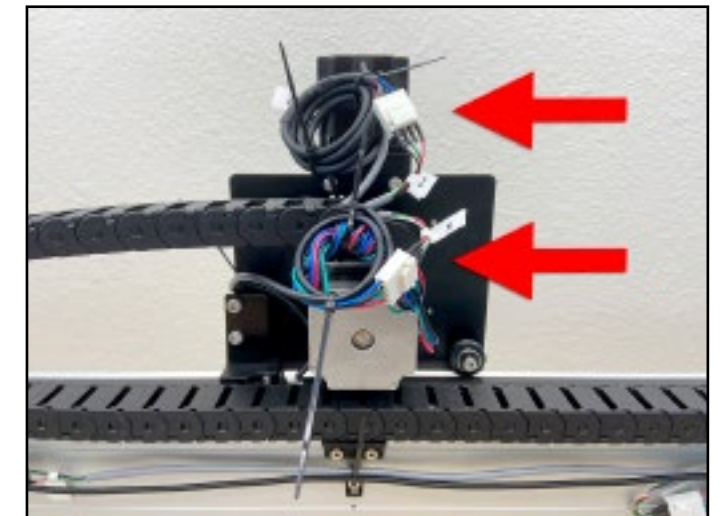

Figure 9-8

Apply the Owner's Decal

1. Write your name on the owner's decal with the included permanent marker and apply it to the inside of the Y1-rail. See **Figure 9-9**.



Figure 9-9

Step 10

Compact Router

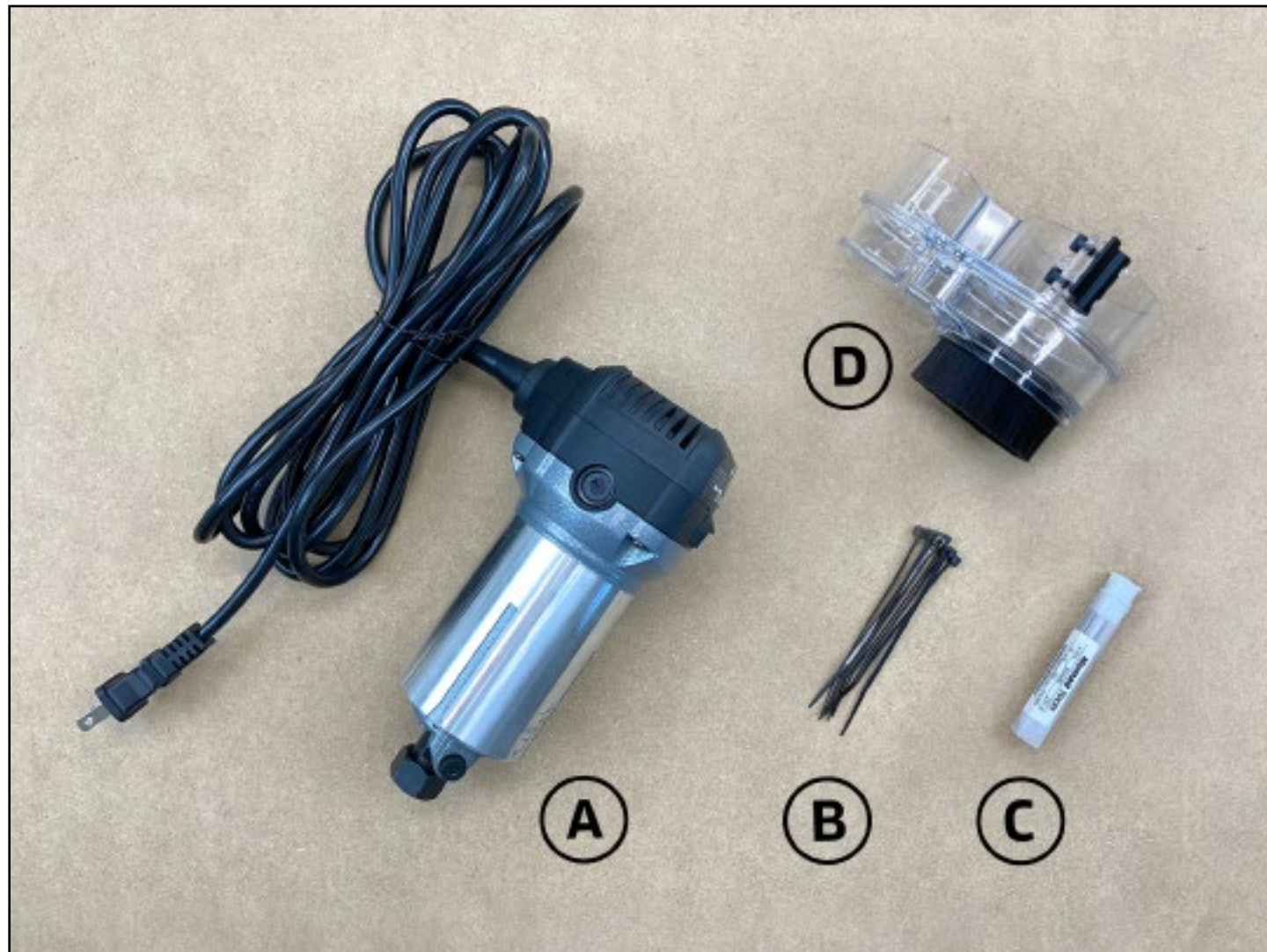
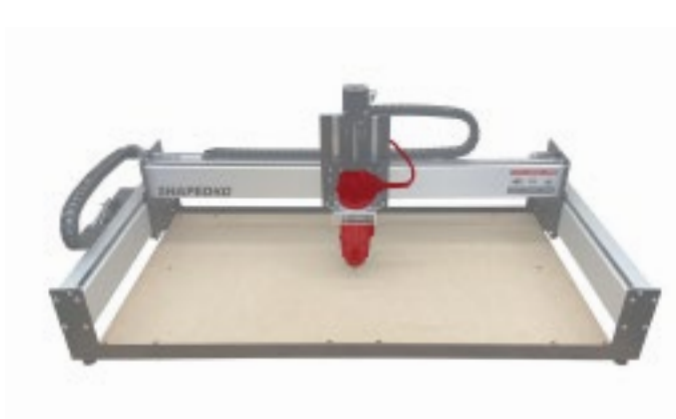

Figure 10-2

Required Components

See **Figure 10-2**:

Item	Description	Location	Qty
A	Compact Router	Compact Router Box	1
B	Cable Ties	XL Wiring Harness Box	6-7
C	#201 1/4-inch Square End Mill Cutter	XL Final Assembly Box	1
D	Sweepy Dust Boot	Sweepy Box	1

Required Tools

See **Figure 10-3**:

Item	Description	Qty
A	4mm Hex Key	1
B	Flush Cut Pliers or Scissors (not included)	1
C	13mm Wrench*	1
D	22mm Wrench*	1

*Found in the Carbide Compact Router box.

Install the Compact Router

The router mount supports a 65mm or 69mm diameter router. 65mm routers, including the Carbide Compact Router, require the use of the router mount adapter ring (inserted in step 3).

Before installing any router, the Z-carriage must be lowered. To lower, press down on the top edge of the Z-carriage plate, in front of the linear rails, with your thumbs (completed in Step 3).

1. Use the 4mm hex key to loosen the two (2) M5x55mm socket head cap screws on the front of the router mount.
2. Insert the router into the mount until the taper of the router's body meets the adapter ring. Extend the power cord to the right. See **Figure 10-4**.
3. Use the 4mm hex key to secure the compact router by tightening the two (2) M5x55mm socket head cap screws on the front of the router mount as shown in **Figure 10-4**.

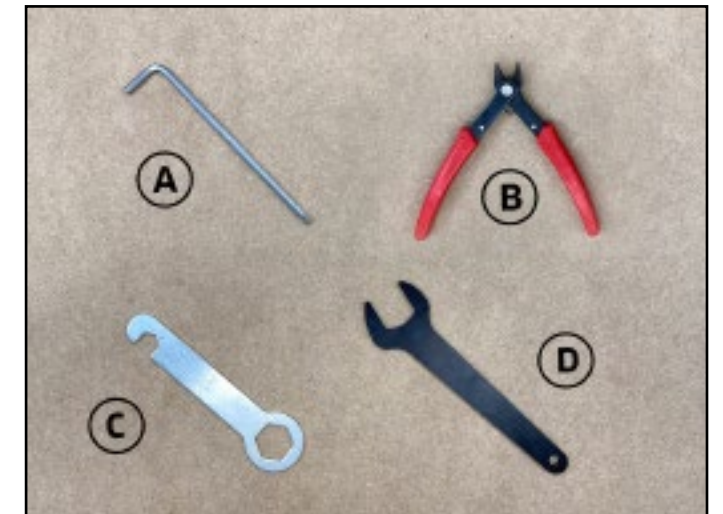

Figure 10-3



Figure 10-4

Secure the Power Cord

NOTE: The router's power cord can cause electromagnetic interference with the stepper motor extension cables and the USB cable. We do not recommend inserting the cord into, or attaching it to the outside of, the drag chain. We will route it away from these cables toward the Y2-carriage and attach it to the X-rail using a cable tie chain.

1. Direct the power cord around the right side of the Z-Plus, through the drag chain loop and next to the X-motor. See **Figure 10-5**.
2. Use one (1) cable tie to secure the power cord to the **TOP-RIGHT** X-motor standoff. Leave enough slack to allow the Z-carriage to move freely up and down. See **Figure 10-5**.
3. Position the Z-Plus next to the Y1-carriage, and loosely extend the power cord across the machine, behind the X-rail, and through the cutout at the top of the Y2-carriage.
4. Use two cable ties to create a two-link cable tie chain on the center cable tie mount at the back of the X-rail. Use the cable tie mount's open bottom attachment point. Make each chain link approximately 1-inch in diameter.
5. Use a third cable tie to secure the router's power cord to the chain. See **Figure 10-6**.
6. Secure the power cord on either side of the Y2-carriage cutout with a few cable ties to keep it from sliding back and forth. The cord should be relatively slack, but not so slack that there's a chance it could get sucked in the router or a motor. See **Figure 10-7**.
7. Trim down the ends of the cable ties. You may wish to leave the ends on the cable ties securing the power cord at the Y2-carriage cutout as they may help hold the power cord in place.



Figure 10-5



Figure 10-6

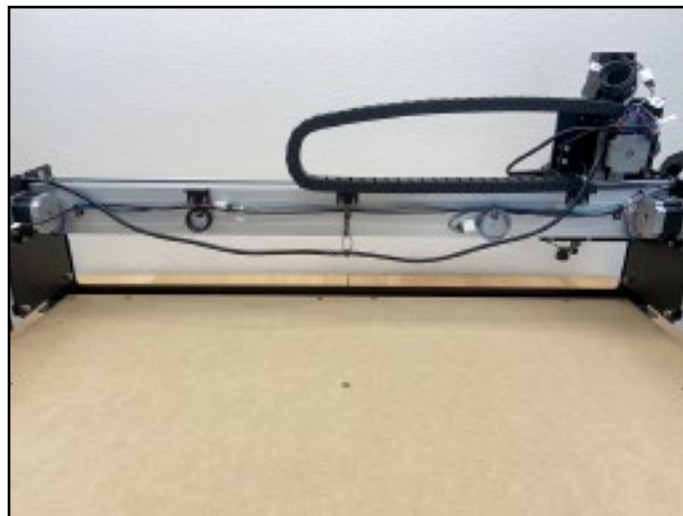

Figure 10-7

Install Sweeepy Dust Boot

1. Fully seat the upper half of the dust boot onto the router's lower motor housing with the 36mm dust port facing forward and toggle the quick release to tighten. See **Figure 10-8**.
2. The lower half locks into place using neodymium magnets for easy install and removal during tool changes.



Figure 10-8

Install an End Mill

These instructions are specific to the Carbide Compact Router. For all other routers, refer to the router user manual for detailed operating, safety, and end mill installation information.

The Carbide Compact Router includes a 0.25" collet cone, a collet nut, a 22mm collet nut wrench, a 13mm spindle wrench, and the XL kit comes with a #201 1/4-inch flat end mill.

Install the End Mill

1. Clean and insert the end mill shank into the loosened collet a minimum of 0.75" (20mm), the entire length of the collet cone and nut. See **Figure 10-9**.
2. Use the 22mm collet nut wrench and the 13mm spindle wrench to tighten the collet nut securely. See **Figure 10-10**. Alternatively, you can press and hold the shaft lock while tightening with the 22mm collet nut wrench. **Never tighten the collet nut without an end mill inserted into the collet cone.**



Figure 10-9

Remove the End Mill

1. To remove the end mill, follow the installation procedure in reverse.

NOTE: Plug the compact router into an outlet with a dedicated on/off switch. Ensure this is accessible while the machine is running, in case you need to shut off the Shapeoko immediately.

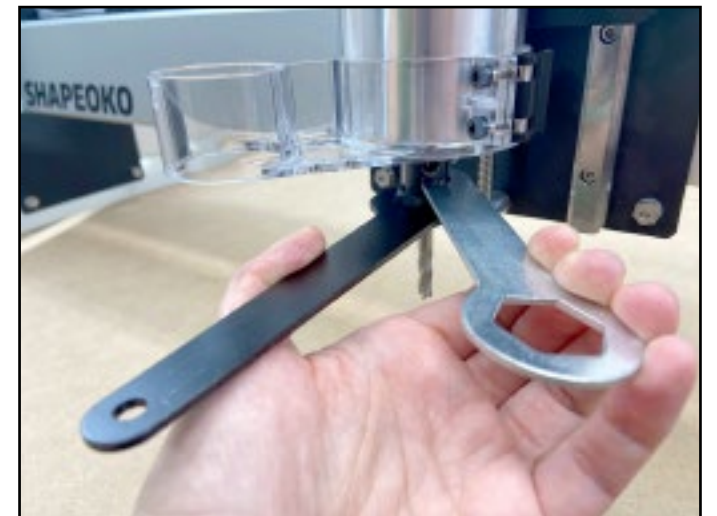

Figure 10-10

Step 11

Level and Square



Required Tools

See **Figure 11-2**:

Item	Description	Qty
A	3 and 4mm Hex Key	1
B	10mm Wrench	1
C	Level (not included)	1

Recommended Tools

See **Figure 11-2**:

Item	Description	Qty
D	Tape Measure	1
E	10mm Combination Wrench	1

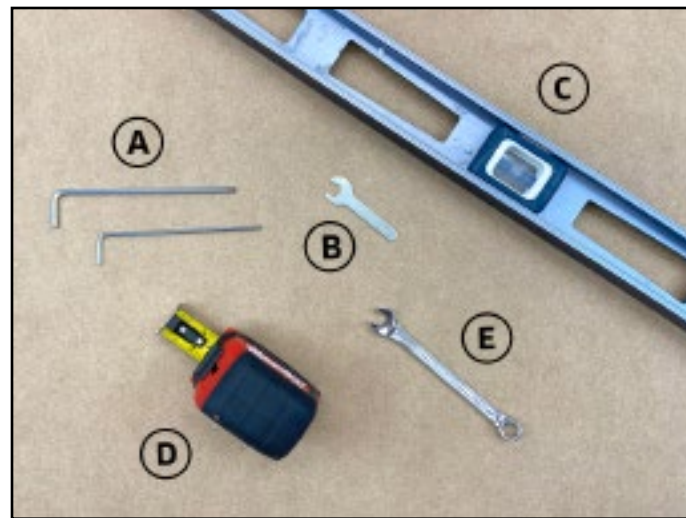

Figure 11-2

Confirm Level

The baseframe received a preliminary leveling in step 2.

1. Double-check for level now at several different points across the machine: front-to-back, side-to-side, and diagonally. Adjust the four (4) leveling feet where necessary.

Confirm Tension of the V-Wheels

The V-wheels were tensioned in step 4.

1. Double-check each one now and adjust where necessary. Refer back to **Figure 3-4** and **3-5** (page 18) for a detailed explanation of eccentric nuts and instructions on tensioning V-wheels.

Square the Machine

The machine is gradually brought into square by first loosening all structural support screws, then tightening again while **SIMULTANEOUSLY** holding the X-rail parallel to the front and rear endplates.

1. Use the 4mm hex key to loosen all twenty-four (24) M6x12mm button head cap screws 1/2 turn back from snug (there are four (4) in the ends of each aluminum extrusion rail).
2. If necessary, use the 3mm hex key to loosen the fifteen (15) M5x25mm button head screws securing the baseplate to baseframe (these screws were not tightened in step 2).



Figure 11-3

PRO TIP: During this step of the assembly, it may be helpful to have another set of hands.

3. With all thirty-nine (39) structural screws now loose, **HOLD** the X-rail **FORWARD**, bringing both Y-carriage plates squarely into contact with the front endplate. See **Figure 11-3**.
4. Maintain **FORWARD PRESSURE** and use the 4mm hex key to fully tighten the sixteen (16) M6x12mm button head cap screw sets 1-4, in numbered order, shown in **Figure 11-4**.
5. Move the X-rail to the rear and maintain **REARWARD PRESSURE** and use the 4mm hex key to fully tighten the eight (8) M6x12mm button head cap screw sets 5-6, in numbered order, shown in **Figure 11-4**.
6. Use the 3mm hex key to fully tighten the fifteen (15) M5x25mm button head cap screws of the MDF baseplate.

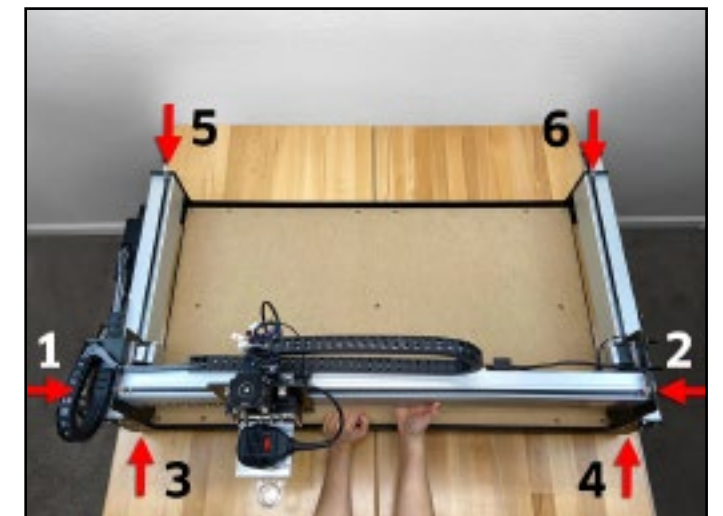

Figure 11-4

Congratulations! Assembly is now complete!

Next Steps

On the following pages you will find helpful information to get you ready to use your Shapeoko XL.

1. Connect to Power
2. Download the Software
3. Configure Carbide Motion 5
4. Run the Test Project
5. Workholding
6. Cutting Tutorials & Projects
7. User Guides & Video Tutorials

Connect to Power

Required Components

See **Figure 12-1**:

Item	Description	Qty
A	Power Supply	1
B	Power Cord	1

1. Connect the power cord to the power supply.
2. Connect the power supply to the power port on the rear of the Carbide Motion board as shown in **Figure 12-2**.
3. Plug power cord into an outlet. A green LED on the power supply will light up when connected to power. See **Figure 12-2**.
4. Flip the in-line rocker switch on the power cord to the ON position. You will hear the motors begin to hum and a blue LED on the Carbide Motion board will be visible through a slit in the enclosure cover. See **Figure 12-2**.

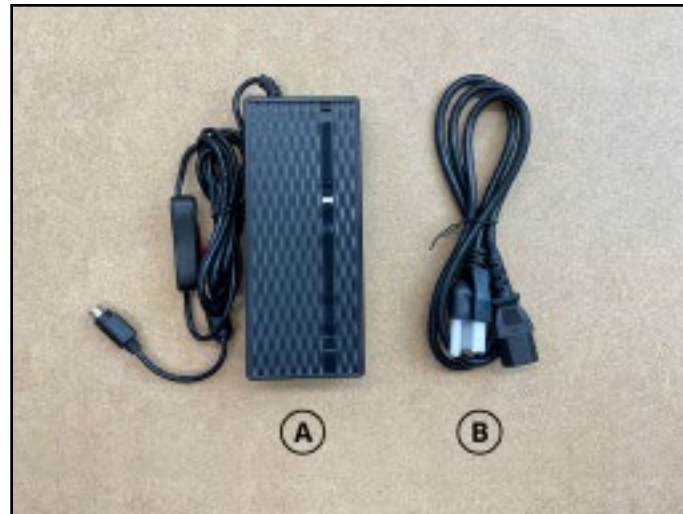

Figure 12-1



Figure 12-2

Download the Software

1. Download Carbide Motion 5 from: carbide3d.com/carbidemotion/download.
2. Download Carbide Create from: carbide3d.com/carbidcreate.
3. Install both programs to your computer.

Carbide Motion lets you control your machine by jogging it around, setting zeros, and loading and running G-code. Carbide Create is a cross-platform CAD/CAM program used to design projects for the Shapeoko. It allows you to create 2D sketches, generate toolpaths, and export G-code which you will run in Carbide Motion to implement your design.

Configure Carbide Motion 5

Required Components

See **Figure 13-1**:

Item	Description	Qty
A	USB Cable	1

Connect to Carbide Motion 5

1. Turn your computer on.
2. Connect the USB cable to the USB port on the rear of Carbide Motion board and to your computer.
3. Start Carbide Motion 5 on your computer.
4. Flip the in-line rocker switch on the power cord to the ON position to turn on the Shapeoko XL.
5. In Carbide Motion, click the **Connect to Cutter** button.

Upload Your Settings

1. Once your screen reads "Job Info," click the **Settings** button in the top menu bar to open the Settings menu. See **Figure 13-2**.
2. Choose "XL" from the **Size** dropdown list, "Z-Plus (Leadscrew)" from the **Z-Axis Type** dropdown list, and "Inches" from the **Units** dropdown list. See **Figure 13-3**.
3. Click the **Update Shapeoko Configuration** button in the middle of the dialog window. See **Figure 13-3**.
4. A progress bar will appear at the top of the window. When the configuration settings have finished sending, click the **OK** button in the bottom-right corner of the window to close it.



Figure 13-1

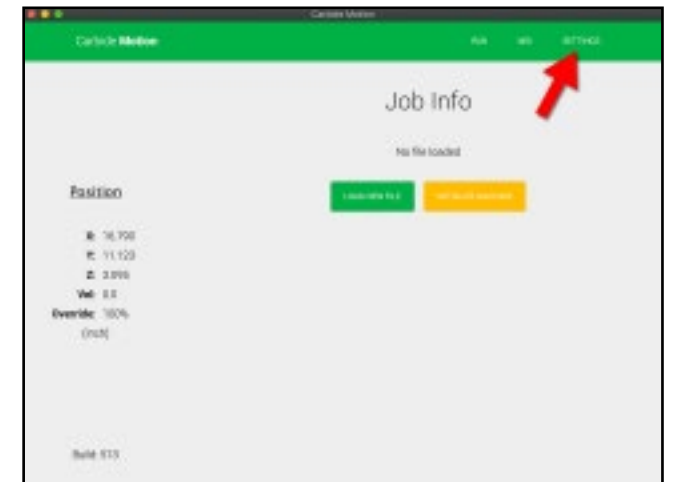

Figure 13-2

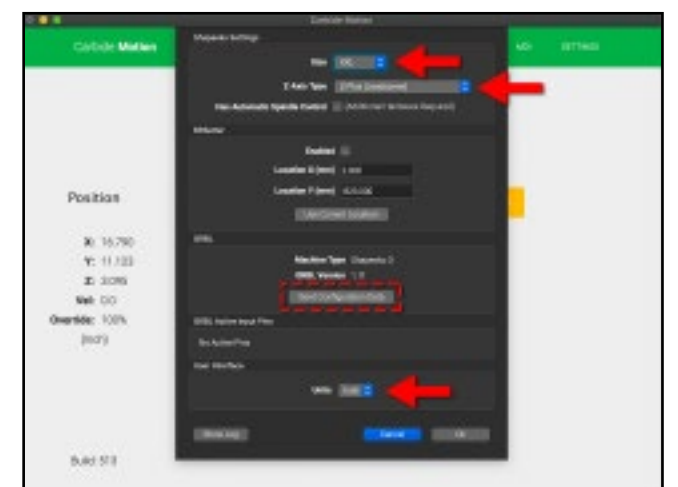

Figure 13-3

Initialize the Proximity Switches

- Click the yellow **Initialize Machine** button. See **Figure 13-4**. This activates the homing sequence and your machine will do the following:
 - The Z-Axis will move up (the positive direction) until the Z-Axis proximity switch is engaged. The Z-Axis will then back off slightly before re-engaging the switch and then backing off for a final time and setting the Z-Axis to machine origin.
 - The X- and Y-Axis will begin to move. The X-Axis will move to the right (the positive direction) and the Y-Axis will move to the back (the positive direction).
 - The X- and Y-Axis will continue to move until one of their switches is triggered, at which time they will follow the same pattern as the Z-Axis: engage the homing switch, back off, re-engage, and then back off again.
- When all three axes have homed, your router will be in the back-right corner.

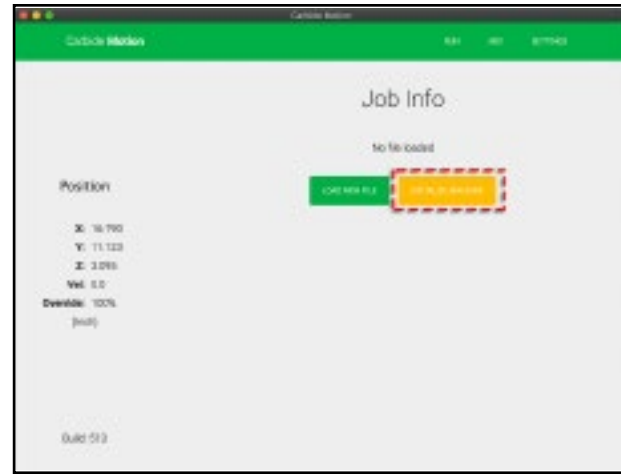

Figure 13-4

Troubleshooting Homing Issues: docs.carbide3d.com/software-faq/home-switch-troubleshooting

Test Project

NOTE: We recommend you use the test project as a practice run before moving on to cutting projects.

Required Components

See **Figure 14-1**:

Item	Description	Qty
A	Permanent Marker	1
B	Large Zip Tie	2
C	Letter-Sized, A4, Paper (not included)	1
D	Masking Tape (not included)	1
E	Piece of Cardboard (not included)	1

Complete the Test Project

To complete the test project (see **Figure 14-2**), follow the instructions: docs.carbide3d.com/tutorials/hello-world.

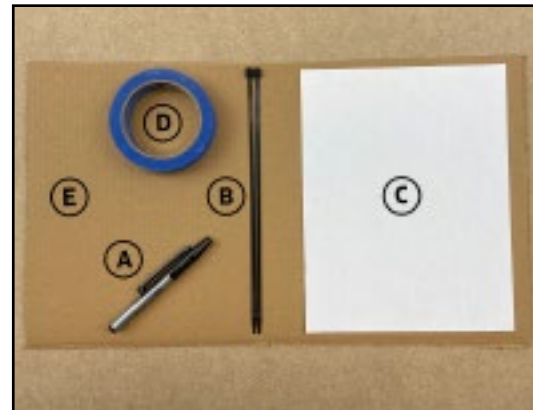

Figure 14-1



Figure 14-2

Workholding

Regardless of what type of project you are making, the first thing to figure out is how you will secure the material to the machine. This concept is called workholding. There are several common ways to hold material down. The specifics of your project, part, material, and other requirements will determine which method you should use. The main objective for workholding is to secure your material to the machine in a way that will not yield to the forces of machining. The most common forms of workholding are:

- Double-sided tape
- Direct fastening (screws, brad nails, etc.)
- Top clamps
- Vise
- Machinable fixturing wax
- Vacuum table

DIY Workholding Projects

Hold-Down Solution: Make a DIY hold-down solution to put on top of your baseplate: cutrocket.com/p/5df928247387d.

Hold-Down Clamps: Make a set of clamps to use with the DIY hold-down solution: docs.carbide3d.com/tutorials/shapeoko-clamps.

Workholding Solutions Available in the Carbide 3D Store



T-Track and Clamp Kit

The T-track system sits on top of your baseframe and provides a flexible, reliable way to hold down material to your Shapeoko XL. The kit includes everything you need to add this system to your machine!

Purchase:
shop.carbide3d.com/collections/accessories/products/t-track-table



Gator Tooth Clamps

Use these ultra-low-profile Gator Tooth Clamps as a backstop, a side clamp, or a toe clamp. With over 30mm of lateral travel, these beasts will hold your job down safely and securely. Clamps come in anodized aluminum or stainless steel.

Purchase:
shop.carbide3d.com/collections/accessories/products/gatortooth



Threaded Inserts

Create a simple DIY workholding solution by threading these inserts into a wasteboard to put on top of your baseplate. Or use a few to hold down material in a jig. Inserts come in packs of 100.

Purchase:
shop.carbide3d.com/collections/accessories/products/threaded-inserts-qty-100



Double-Sided Tape

This high-quality double-sided tape is ideal for holding down PCBs or other flat stock for machining. The tape is 0.75" wide, 5 mil thick, 36 yards long, and it has 66 ounces per inch adhesion.

Purchase:
shop.carbide3d.com/collections/accessories/products/double-side-tape

Cutting Tutorials and Projects

Once you have implemented a workholding solution, you're ready to tackle some beginner tutorials and projects!

The Star Wars Coaster Project is an excellent crash course on how to use your Shapeoko XL. The tutorial walks you through designing a simple set of coasters in Carbide Create and then executing the project with Carbide Motion.

Follow the complete project tutorial at: docs.carbide3d.com/tutorials/project-coaster.

More Beginner Tutorials

Once you've completed the coaster project, you can find more beginner cutting tutorials on the Carbide 3D docs site. Each tutorial will get you more comfortable using Carbide Create to set up your design and Carbide Motion to run the cutting project. Here are a few great tutorials to get you started:

MAKE Makey Wall Plaque: docs.carbide3d.com/tutorials/makey

Weber Sign: docs.carbide3d.com/tutorials/tutorial-signs/weber-sign

Nerd Coasters: docs.carbide3d.com/tutorials/project-nerdcoasters

Projects on CutRocket

Visit cutrocket.com, the Carbide 3D project site, to explore even more cutting projects for your Shapeoko XL. On CutRocket you'll find a wide variety of projects: signs, toys, games, tools, art, and storage and organization—and the complete project files for each. These projects will level up your machining skills and get you inspired to create your own projects!

User Guides and Video Tutorials

As you get started running beginner projects with your Shapeoko XL, we also recommend you browse through our Carbide 3D docs site: docs.carbide3d.com. We've packed the docs site full of all kinds of useful information to help you get up and running with your Shapeoko XL, and to help answer common questions you might run into.

User Guides and Videos

Carbide Create Video Tutorials: Watch the videos at docs.carbide3d.com/assembly/carbidecreate/video-tutorials

Carbide Motion User Guide: Check out the User Guide at docs.carbide3d.com/assembly/carbidemotion/userguide

YouTube Channel: Check out the Carbide 3D YouTube channel for awesome tips and tricks, video tutorial projects, machining how-tos, and new product releases at youtube.com/carbide3d

Tooling and Tool-Change

Carbide 3D Tooling Guide: Learn about the different types of end mills and how to choose the right tool for your project at docs.carbide3d.com/tutorials/tutorial-tooling

Tool Change Tutorial: Learn how to use multiple tools on a single job (excellent information about homing, job zero, and creating a repeatable offset) at docs.carbide3d.com/tutorials/tool-change

Shapeoko Feeds and Speeds Chart: This chart shows the cutting speed (how fast the machine goes through a given material using a given cutting tool) and feed rate for different types of materials and different sizes and types of end mills: docs.carbide3d.com/support/supportfiles/S3_feeds_250.jpg

Troubleshooting and How To Guides

Can't Connect to Machine or Jog: docs.carbide3d.com/software-faq/can-t-connect-to-machine-or-jog

Tightening Eccentric Nuts to Tension V-Wheels: docs.carbide3d.com/support/tensioning-eccentrics

Power Supply Usage (Is it Working?): docs.carbide3d.com/shapeoko-faq/power-supply-usage

Glossary of Terms

Collet: Cone-shaped sleeve that holds an end mill in place in the router.

Eccentric Nut: Often referred to as offset nuts, offsets, and eccentrics, are nuts with an attached spacer, serves as axle, and off-center threads, creating a cam. They convert rotational motion into linear motion and are used in conjunction with V-wheels to apply tension at the V-rail and eliminate carriage slop.

End Mill or End Mill Cutter: Cutting tools used by a CNC machine. End mills are similar to drill bits, though, typically they can cut in all directions. End mills come in several varieties, including square, ball nose, and v-bit, and many sizes. Learn more about end mills here: docs.carbide3d.com/tutorials/tutorial-tooling.

G-code: G-code (general, or geometric, code) is a CNC programming language that controls when, where, and how the machine tools move across the workpiece. For example, when to turn on or off, how fast to travel to a particular location, what paths to take, etc.

Gantry: A multi-axis motion system of rails and carriages supported on the sides by, and spanning over, the baseframe, giving the spindle overhead access to a workpiece.

PEM Nut: Penn Engineering & Manufacturing Corp. brand fastener, providing self-clinching, permanent threads and mounting points in thin sheet metal.

Slop: Unwanted movement in the gantry at the carriages due to under tensioned V-wheels.

Toolpath: A toolpath is the "route" the cutting tool will follow as it shapes the workpiece. We use Carbide Create, Carbide 3D's cross-platform CAD/CAM program, to define the toolpaths for a project.

Working Envelope: A working envelope is the CNC machine's range of movement across each of its three axes, X, Y, and Z. This may extend beyond the Shapeoko's front endplate.

Workpiece: A workpiece is a stock piece, the sheet of material to be milled.